

SMART Digest ImmunoAffinity (IA) Kit User Manual

Version 1

XX21549-EN 0816S Revision A • August 2016

SMART Digest ImmunoAffinity (IA) Kits

Delivering Fast, Simple and Highly Reproducible Immunocapture and Digestion of Proteins

The Thermo Scientific™ SMART Digest™ ImmunoAffinity (IA) Kits are designed for biomarker quantitation. These proteins are often present at low levels in complex biological matrices. Immunoaffinity capture is typically employed to purify the sample and increase sensitivity. This step is often followed by protein digestion.

The SMART Digest IA kit is designed to remove the issues often associated with sample preparation of proteins by delivering a process which is:

- **Fast**
- **Simple**
- **Highly reproducible**
- **Sensitive**
- **Compatible with automation**

The SMART Digest IA kit achieves this by its unique design where the immunoaffinity reagents (either streptavidin, protein A or protein G) and heat activated thermally stable trypsin are co-immobilized onto a single bead.

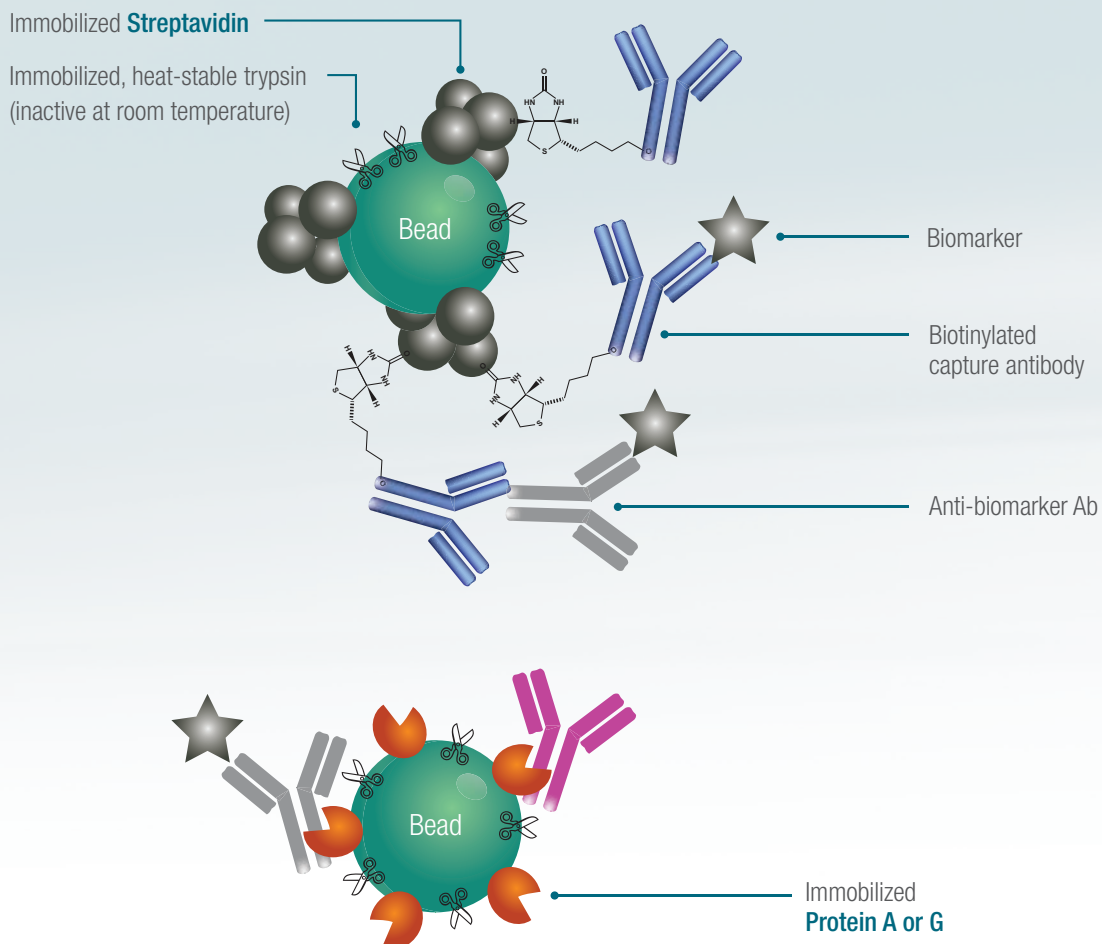

Following the binding of a capture reagent to the bead, and enrichment of the target, the enzyme is activated at elevated temperatures for accelerated digestion under protein denaturing conditions. The resulting workflow is faster and easier than the traditional process. Magnetic and non-magnetic versions of the beads are available.

SMART Digest IA workflow compared to a traditional protein sample preparation workflow

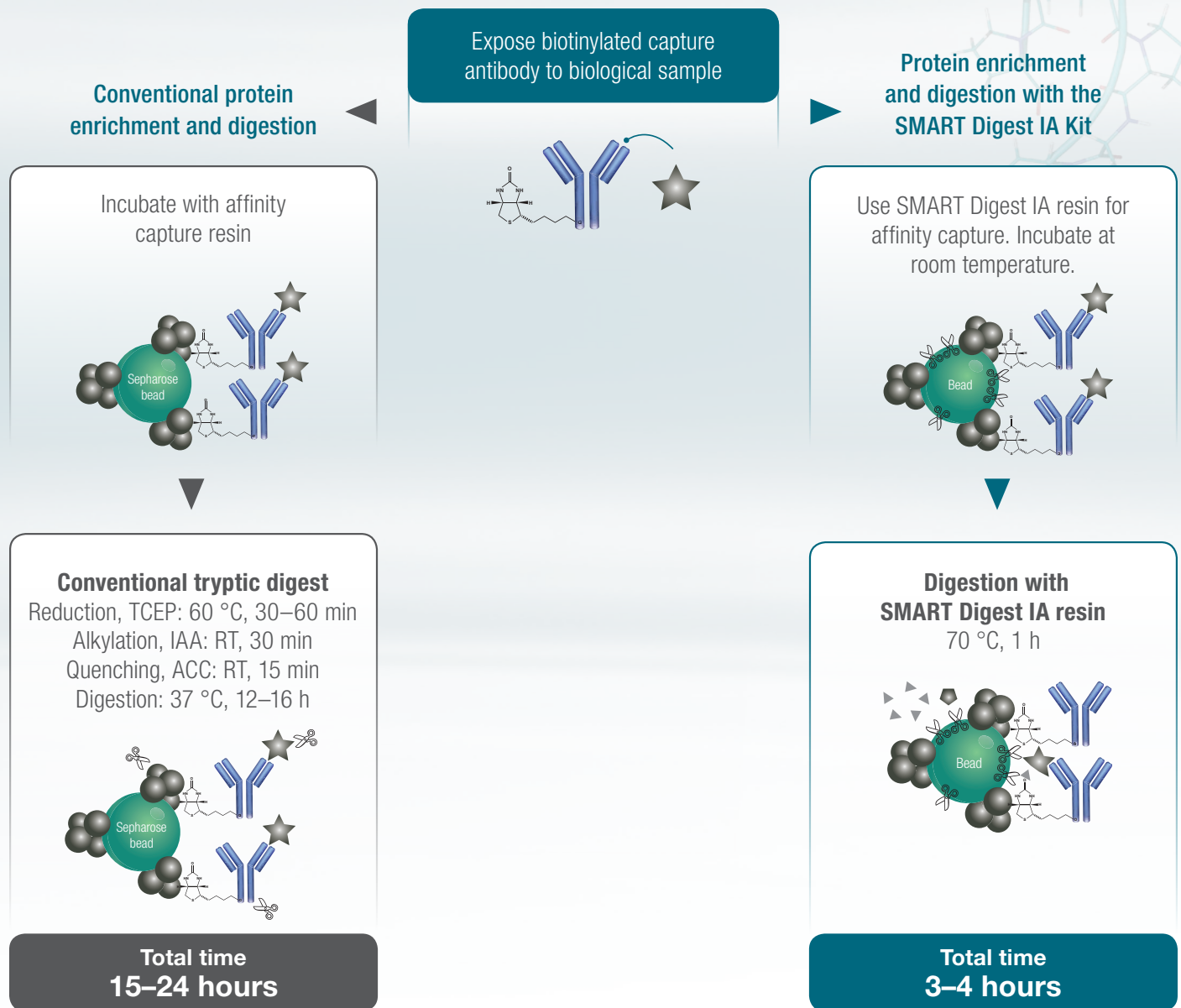

How to use the SMART Digest IA Kit

Preparing a Biotinylated Capture Moiety SMART Digest IA Kit, Streptavidin

Preparation of biotinylation solution

- Weigh out 5 mg of N-hydroxysuccinimide (NHS)-Biotin in a 1.5 mL tube.
- Add 1 mL dimethylsulfoxide (DMSO) to make a solution of 5 mg/mL NHS-Biotin in DMSO

Biotinylation of antibody or capture moiety

- As needed, dilute the stock solution of your antibody, or capture moiety to a working concentration by addition of PBS or other amine free buffer.
- To the working solution add 5 μ L of 5 mg/mL biotinylation solution for each milligram of antibody or capture moiety in your working solution and mix thoroughly. For biotinylation of proteins at varying concentrations, see the table below.
- Allow the solution to react with continuous mixing at 1400 RPM, for at least 2 hours.
- Once the capture moiety is biotinylated, ≤ 5 μ g of the biotinylated materials may be bound to every 30 μ L of the beads.
- Add the biotinylated materials to the beads and allow them to react with continuous mixing at 1400 RPM, for at least 30 minutes.
- For bulk modifications, the beads should be reduced to their original volume following the binding of the capture moiety to the beads to allow for optimal dispensation (see page 7).

		NHS-Biotin guide for protein biotinylation					
		Recommended Volume of 5 mg/mL NHS-Biotin (μ L)					
		Protein Molarity (nM)					
		0.1	1	5	10	25	100
Sample Volume (mL)	1	0.08	0.82	4.1	8.19	20.48	81.94
	0.5	0.04	0.41	2.05	4.1	10.24	40.97
	0.25	0.02	0.2	1.02	2.05	5.12	20.48
	0.1	0.01	0.08	0.41	0.82	2.05	8.19

Note: The optimum amount of biotin per protein is detailed in the table above. Too much biotin will leave remaining free biotin to outcompete for streptavidin binding sites on the SMART Digest IA resin. However, too little will result in insufficient biotinylation of the antibody, or protein for capture. This titering eliminates the need to dialyze, or otherwise remove any unreacted biotin from the antibody.



Cross-linking Procedure

SMART Digest IA Kit, Protein A and G

Preparation of glutaraldehyde solution

- Make a solution of 0.01% glutaraldehyde in DMSO.

Antibody capture

- Incubate 5 µg of your antibody with 30 µL SMART Digest IA Protein A or G resin for 30 minutes at room temperature and 1400 RPM. For bulk modifications, scale the protocol as needed.
- Wash the resin with PBS* 3 times: centrifuge the resin, decant the majority of the supernatant, and then re-suspend the resin in fresh buffer. After the final wash, leave 45 µL of solution for every 30 µL of original slurry.

*The washing step may be performed with a buffer other than PBS, as long as it is amine free.

Cross-linking

- For every 45 µL of solution, add 5 µL of the 0.01% glutaraldehyde solution and incubate for 2.5 hours at room temperature and 1400 RPM.
- For every 50 µL of solution add 10 µL of 500mM TBS to quench any remaining glutaraldehyde. Incubate at room temperature and 1400 RPM for at least 10 minutes.
- When performing bulk modifications, the beads should be reduced to their original volume following the quenching step to allow for optimal dispensation (see page 7). For every 60 µL of solution present following the quenching step, 30 µL of supernatant should be decanted.

Preparation of Beads: Component 1

SMART Digest IA Kit, Streptavidin

- With the SMART Digest IA Streptavidin kit, biotinylated capture reagents may be added directly to the beads prior to sample addition.
- For every 30 μL of beads, add ≤ 5 μg biotinylated antibody or capture moiety.
- When performing bulk modifications, the beads should be reduced to their original volume following the binding of the capture moiety to the beads to allow for optimal dispensation (see page 7).

SMART Digest IA Kit, Protein A and G

- With the SMART Digest IA Protein A and G kits capture antibodies may be added directly to the beads then cross-linked into place as part of a targeted workflow.
- For every 30 μL of beads, add ≤ 5 μg of antibody.
- When performing bulk modifications, the beads should be reduced to their original volume following the binding of the capture moiety to the beads to allow for optimal dispensation (see page 7).
- Alternatively, samples can be added directly to the SMART Digest IA Protein A and G beads for bulk fractionation of immunoglobulins. For this workflow, no cross-linking is required.

Preparation of the Wash Buffer: Component 2

- Dissolve the contents of the Wash Buffer packet into 500 mL of deionized water.
- Add 100 mg NaN_3 (sodium azide) as a preservative and biocide. Once prepared, when not in use, the SMART Digest IA Wash Buffer solution should be stored at 4 $^{\circ}\text{C}$.

Note: Sample dilution is not required for many workflows. If your workflow requires dilution, the wash buffer may be used as sample diluent.

Protein Capture Procedure

1

Re-suspend

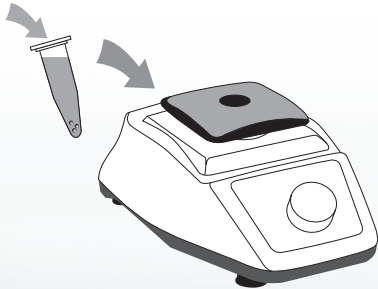

Following preparation of the beads for immunocapture as previously described, vortex the beads until thoroughly suspended.

2

Aliquot

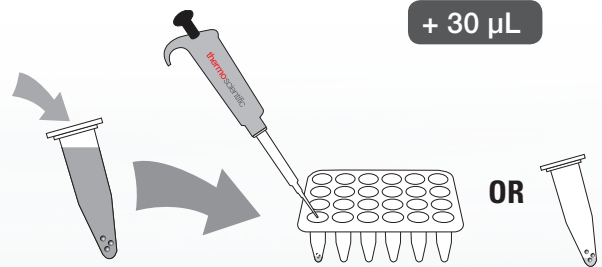

Add 30 μL of the SMART Digest IA beads to each well/tube.

3

Add sample

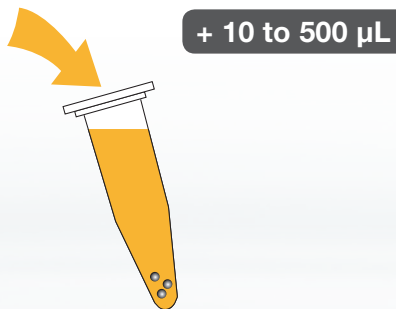

Add 10 to 500 μL of sample to well/tube, containing the SMART Digest IA resin and seal or cap.

4

Incubation

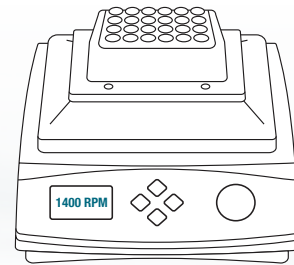

Set heater/shaker to **room temperature**/ 1400 RPM, add plate or tubes and incubate for the required time.

Optimal incubation times will vary and should be validated experimentally; a 120 minute incubation time is a good starting point.

Your sample is now ready for the protein wash procedure.

Protein Wash Procedure

Following the protein capture procedure, the beads need to be separated from the solution.

1

Remove

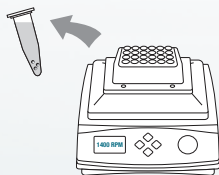

Non-magnetic option

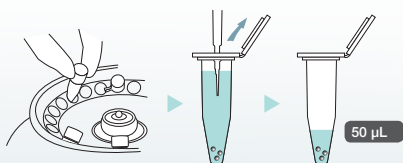

- Centrifuge sample well/tube (1 min, 1300 RPM).
- Following centrifugation uncap the well/tube and reduce the sample volume to 50 µL or $\frac{3}{4}$ sample volume, whichever is less, with a pipette or similar device and discard the supernatant.

Magnetic option

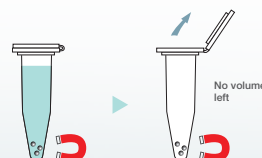

- Place magnet to side of well/tube. The beads will be held in place.
- Following magnetization, uncap well/tube and aspirate all supernatant and discard.

2

Add wash buffer

SMART Digest IA wash buffer

400 µL

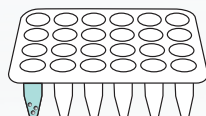

OR



- Add the wash buffer (component 2) to well/tube.
- Final sample volume is 400 µL.

Vortex thoroughly and wash beads.

3

Remove

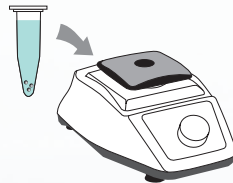

Non-magnetic option

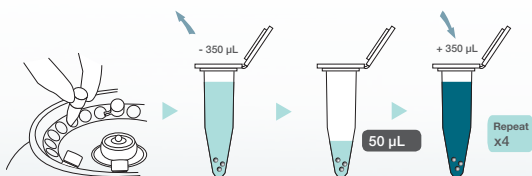

- Centrifuge sample well/tube (1 min, 1300 RPM).
- Remove 350 µL of supernatant.
- Replace with a fresh 350 µL of wash buffer.
- Perform these steps **at least 4 times**.

Magnetic option

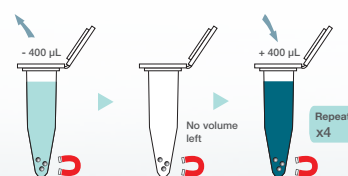

- Place magnet to side of well/tube. The beads will be held in place.
- Remove the entire 400 µL volume of sample.
- Replace with 400 µL of wash buffer.
- Perform these steps **at least 4 times**.

Separate the beads from the solution.

4

Separate

Non-magnetic option

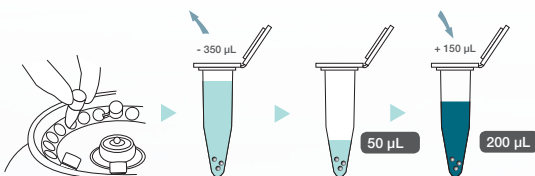

- Centrifuge sample well/tube (1 min, 1300 RPM).
- Remove 350 µL of supernatant and discard.
- Add 150 µL of **SMART Digest IA buffer** (component 3) to your sample up to a final volume of 200 µL.
- Cap wells or tubes.

Magnetic option

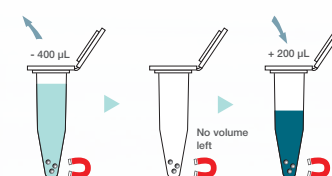

- Place magnet to side of well/tube. The beads will be held in place.
- Remove entire 400 µL of supernatant.
- Add 200 µL of the **SMART Digest IA buffer** (component 3) to your well/tube to give a final volume of 200 µL.
- Cap wells or tubes.

Protein Digestion Procedure

For both non-magnetic and magnetic options.

1

Digestion

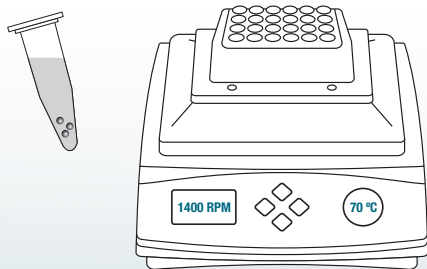

Set your heater/shaker to **70 °C/1400 RPM**, allow to equilibrate for 5 minutes. Then add your sample tube or well for the required time for digestion. Optimal digestion times will vary and should be validated experimentally; a 60 minute digestion time is a good starting point.



Note: Refer to the Digestion Optimization section.

2

Cleanup

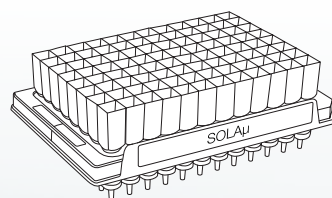

Remove the sample tube or well from the heater/shaker and perform sample cleanup.



Note: Refer to the Post Digestion Process.

3

Analyze

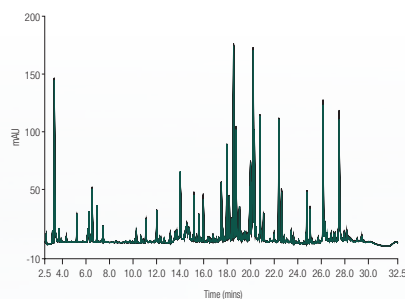

Analyze sample.

Digestion Optimization



Optimize the digestion time for your assay

- Prepare eight identical samples using a relatively high, known concentration of native analyte in SMART Digest IA buffer (component 3).
- Digest the samples according to the Protein Digestion Procedure and periodically remove one of the samples from the well or tube (e.g. every 5 to 15 minutes).
- Perform the appropriate Post Digestion Process.
- Analyze the samples to determine the extent of digestion (see diagram and table).
- Identify signature peptides and monitor their MS response. Once the MS response is consistent digestion is complete, the corresponding digestion time can be used for subsequent analyses.
- In the case of IgG the 937 *m/z* ion was monitored and full digestion is shown to be complete in just over 60 minutes.

IgG Assay *m/z*-937

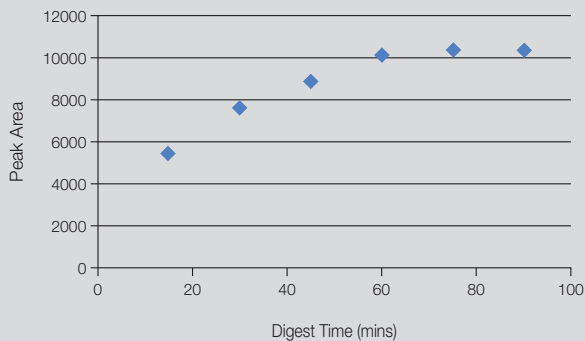

Typical Digestion Times

Protein	Digest Time (min)
Insulin	4
BSA	< 5
Carbonic anhydrase	< 5
Lysozyme	< 5
Apo-B	30
IgG	45
IgG in 50 μ L plasma*	75
Ribonuclease A	150
Thyroglobulin	240
C-reactive protein	240

200 μ L protein solution (100 μ g/mL) at 70 $^{\circ}$ C

*IgG in plasma (17.5 mg/mL total protein) at 70 $^{\circ}$ C

Post Digestion Process



Using SOLA μ SPE Plates

SOLA μ SPE cleanup method

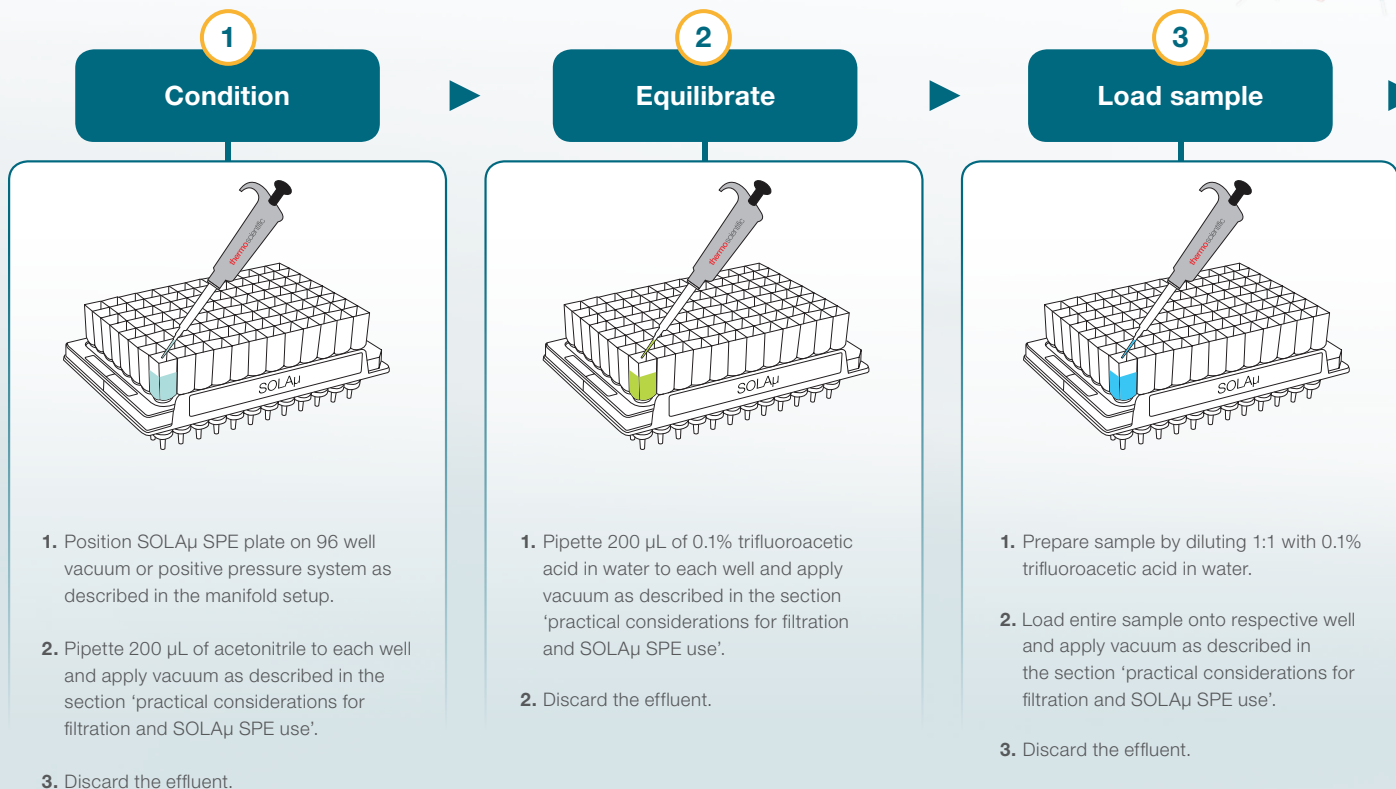

Manifold setup and plate alignment



Filtration plate OR
SOLA μ SPE plate

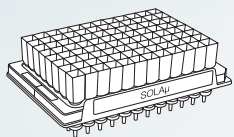

Vacuum manifold top

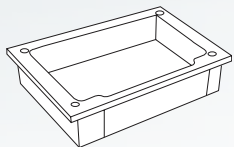

96-well collection plate
in the vacuum manifold
base

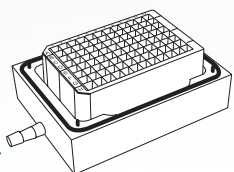

To vacuum pump

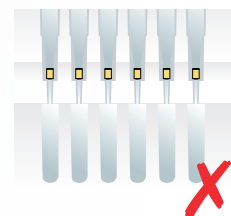
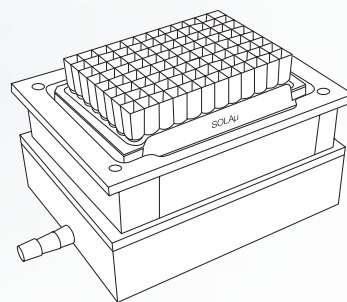

Points to consider

- No gap between filter/SOLA μ plate and collection plate.
- When under vacuum filter/SOLA μ plate will be held tightly in position.

4

Wash

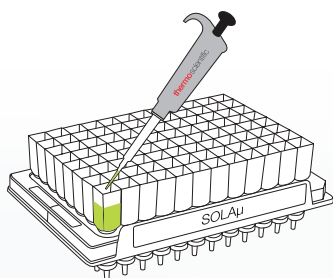

1. Pipette 500 μL of 0.1% trifluoroacetic acid in water to each well and apply vacuum as described in the section 'practical considerations for filtration and SOLA μ SPE use'.
2. Discard the effluent.

5

Elute peptides

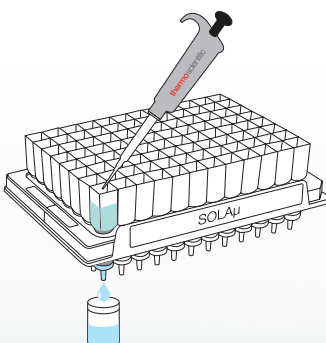

1. Pipette 25 μL of 70% acetonitrile in water to respective wells as described in the section 'practical considerations for filtration and SOLA μ SPE use'.
2. Repeat this process until a total volume of 50 μL has passed through the plate.
3. **Collect sample** in appropriate vessel for analysis.

6

Analyze

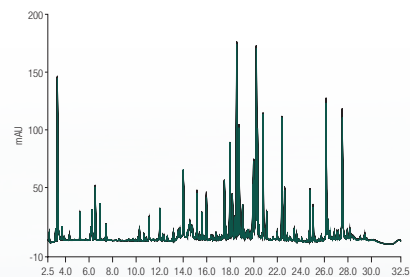

1. To your sample add 50 μL of 0.1% formic acid and mix prior to analysis.

Practical considerations for the use of filtration and SOLA μ SPE plates

1. Using an accurate pipette, aspirate the specified volume of either solvent/reagent, or sample.



2. Dispense solvent/reagent or sample into a unique 'well' of the filtration or SOLA μ SPE plate. Up to 96 wells can be used simultaneously.

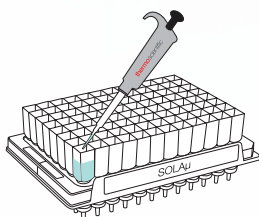

3. Apply a gentle vacuum and increase the pressure until the liquid begins to flow through the filtration, or SOLA μ SPE plate.

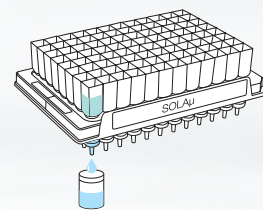

4. The collected eluent is then kept for analysis.

Note: The effluent from each load/wash step may also be collected and analyzed if method optimization is required.

Characteristics

Product Type	Binding Capacity
SMART Digest IA kit, Streptavidin	30 μ L (1350 μ g) of beads bind approximately 5 μ g biotinylated IgG
SMART Digest IA kit, Protein A	30 μ L (1350 μ g) of beads bind approximately 5 μ g IgG
SMART Digest IA kit, Protein G	30 μ L (1350 μ g) of beads bind approximately 5 μ g IgG
Digestion Time	~ 60 minutes or less (see Digestion Optimization section)
Concentration	~ 45 mg beads/mL suspension
Diameter of beads	~ 20 μ m

Operational Specifications

Pre-capture Sample Volume	Post-capture Sample Volume	Capture and Wash Temperature ($^{\circ}$ C)	Digestion Temperature ($^{\circ}$ C)
10–500 μ L	\leq 50 μ L	20–25 $^{\circ}$ C	50–70 $^{\circ}$ C

Ordering Information

Part Number	Description
Streptavidin	
60110-101	SMART Digest IA Kit, Streptavidin (Av) non-magnetic
60110-102	SMART Digest IA Kit, Av non-magnetic with Thermo Scientific™ SOLA μ ™ SPE and collection plate
60110-103	SMART Digest IA Kit, Av magnetic with SOLA μ SPE and collection plate
60110-104	SMART Digest IA Kit, Av magnetic
Protein A	
60111-101	SMART Digest IA Kit, Protein A non-magnetic
60111-102	SMART Digest IA Kit, Protein A non-magnetic with SOLA μ SPE and collection plate
60111-103	SMART Digest IA Kit, Protein A magnetic with SOLA μ SPE and collection plate
60111-104	SMART Digest IA Kit, Protein A magnetic
Protein G	
60112-101	SMART Digest IA Kit, Protein G non-magnetic
60112-102	SMART Digest IA Kit, Protein G non-magnetic with SOLA μ SPE and collection plate
60112-103	SMART Digest IA Kit, Protein G magnetic with SOLA μ SPE and collection plate
60112-104	SMART Digest IA Kit, Protein G magnetic

Product Storage

- Store SMART Digest IA beads at -20 °C.
- Store Digest buffer and dry or reconstituted SMART Digest IA wash buffer at 4 °C.
- All other materials can be stored at room temperature.

Each SMART Digest IA kit ships in cold conditions. Each kit contains a WarmMark^{®2} Temperature Indicator. This indicator tracks how long the kit has been at, or above, 38 °C by irreversibly turning from white to blue.

If on opening the kit the temperature sensor indicates that the kit has been exposed to 38 °C for more than 2 hours please contact Technical Support: www.thermofisher.com/chromexpert to help determine the functionality of the SMART Digest IA kit.

WarmMark^{®2} Time/Temperature Indicator



2 Hours at/or
above 38 °C



Materials recommended but not provided

- Heater/shaker equipped with heated block and heated lid, capable of uniformly heating samples to 70 °C.
- Thermo Scientific™ Matrix™ SepraSeal (P/N 4463) for use with deepwell plates.
- Thermo Scientific™ DynaMag™ -96 Side Magnet block, for use with magnetic bead versions of kit (P/N 12331D).
- The Thermo Scientific™ KingFisher™ Duo Prime, or KingFisher Flex Purification Systems (P/N 5400110 and P/N 5400630 respectively) for use with magnetic bead versions of the kit (high throughput options).

For use with SOLA μ SPE plate operation:

- Thermo Scientific™ HyperSep-96 Well Plate Vacuum Manifold (P/N 60103-351).
- The Thermo Scientific™ Vacuum Pump NA option (P/N 60104-243) or EU option (P/N 60104-241).
- Thermo Scientific™ WebSeal™ 96 Well Collection Plate (P/N 60180-P211).
- WebSeal CLR Silicone 96 Well Mat (P/N 60180-M105).

Recommended column for peptide quantification:

Thermo Scientific™ Acclaim™ VANQUISH™, C18, 2.2 μ m Analytical (2.1 × 250 mm, P/N 074812-V).

Characterize the full diversity of biomolecules

Thermo Scientific™ solutions for biomolecule separations

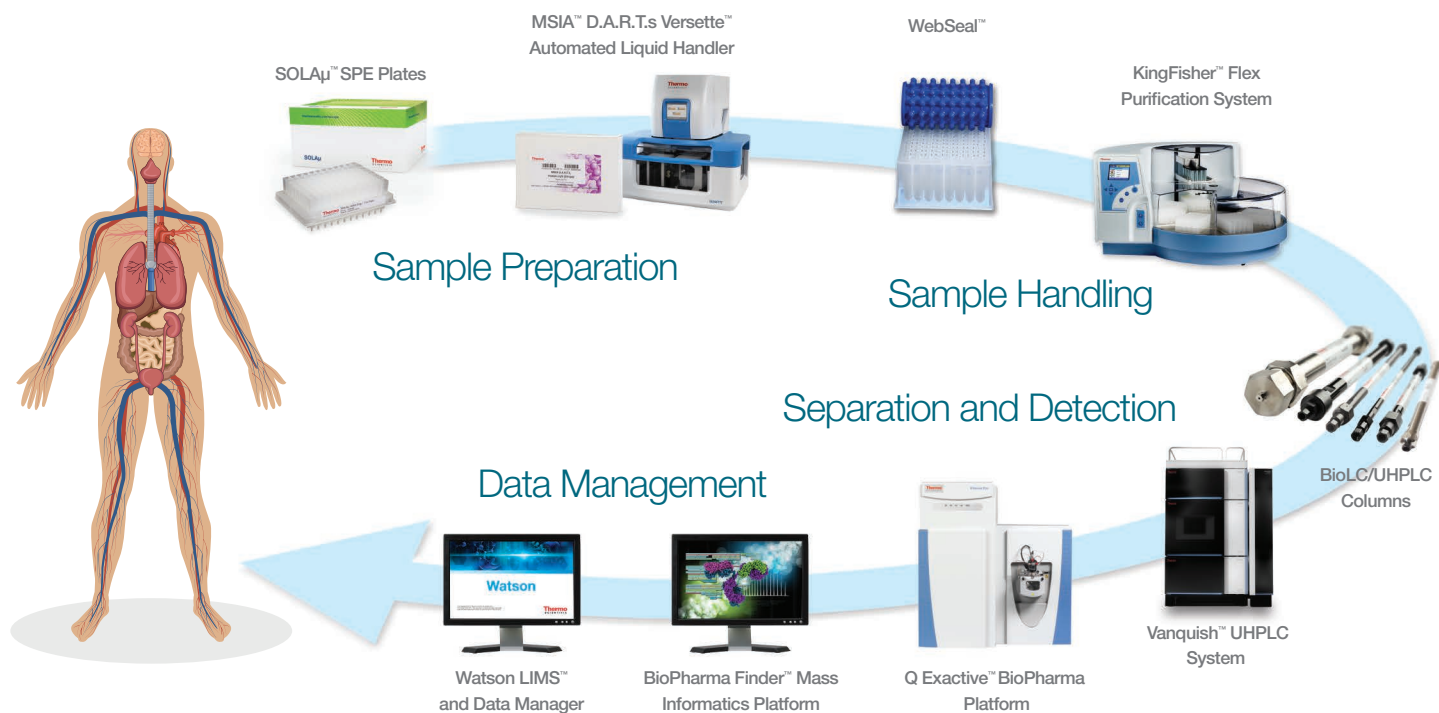

Find out more at thermofisher.com/SMARTdigest

ThermoFisher
SCIENTIFIC