



Mass Spectrometry

Stay ahead
with unstoppable confidence

Thermo Scientific ISQ 7610
Single Quadrupole GC-MS System

Unstoppable confidence in usability, uptime, and results

To stay ahead, analytical testing laboratories need the ultimate confidence of a GC-MS system that easily and reliably produces trusted results, day after day. That's the reason for the Thermo Scientific™ ISQ™ 7610 Single Quadrupole GC-MS System. Simplified operation, automated workflows, and extended dynamic range deliver consistent results from system to system in every laboratory. Thermo Scientific™ NeverVent™ technology, extended-life detector, and intelligent software eliminate unnecessary downtime to maximize sample throughput. To ensure you are ready for any analytical challenge, the system is upgradeable from entry-level to advanced configurations. Now you can take the lead with rapid return on investment (ROI) for your regulated GC-MS analyses.

Combine the ISQ 7610 Single Quadrupole GC-MS System with the Thermo Scientific™ TRACE™ 1600 Series Gas Chromatograph (GC) and Thermo Scientific™ AI/AS 1610 Liquid Autosampler to optimize the performance and productivity of your solution.

Increase instrument uptime

Eliminate unnecessary and unplanned instrument downtime and maximize productivity to achieve unprecedented efficiency, day after day. The ISQ 7610 Single Quadrupole GC-MS System combines unstoppable robustness with the ability to change the GC column and clean the ion source without interrupting your analytical workflows.

Maximize sample throughput

When high sample throughput is essential, the system delivers results on time and with ease. Automated workflows and simplified instrument operation ensure every user produces consistent results, sample after sample. Extended linear range enables method consolidation so you can analyze more compounds at varying concentrations in a single run.

Realize rapid return on investment

Ensuring your system delivers results as soon as it's installed is necessary to achieving rapid ROI. With built-in intelligence that simplifies instrument set up, analytical methods, and everyday operation, the ISQ 7610 Single Quadrupole GC-MS System is designed for accelerated deployment. Reduced needs for operator training and faster time to full productivity together with maximum sample throughput provide fast return on your instrument investment.

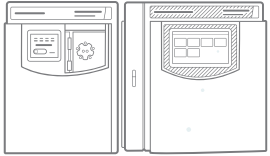

The ISQ 7610 Single Quadrupole GC-MS system coupled to the Thermo Scientific™ TRACE™ 1610 gas chromatograph and TriPlus RSH SMART autosampler.



Environmental



Food safety



Petrochemical



Clinical and toxicology



Pharmaceutical



Unstoppable instrument uptime for full-time productivity

Unplanned or planned downtime can result in poor asset utilization and reduced sample throughput. The ISQ 7610 Single Quadrupole GC-MS System features user-centric innovations that reduce downtime for routine maintenance, while instrument health monitoring assists you in determining when maintenance is needed to avoid unnecessary downtime. As a result, you maximize instrument utilization, sample throughput, and ultimately ROI.



NeverVent technology

Using NeverVent technology with the Vacuum Probe Interlock (VPI) and V-Lock source plug, planned maintenance such as changing columns and ion source cleaning can be performed without venting the mass spectrometer, increasing uptime. The VPI can also be used to avoid venting when changing between electron ionization (EI) and chemical ionization (CI) modes.

ExtractaBrite Ion Source

For over a generation, the Thermo Scientific™ ExtractaBrite™ ion source has provided trusted EI and CI results. The EI ExtractaBrite ion source offers proven robustness and sensitivity that meets regulatory requirements. To adapt to various applications, you can switch between EI and CI modes without breaking vacuum.

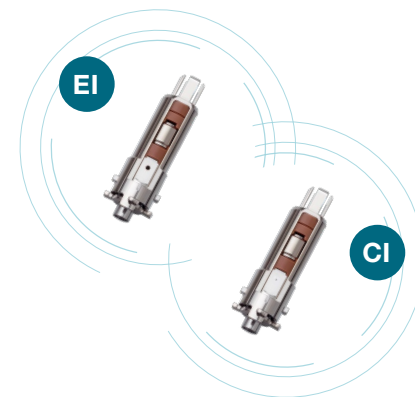

XLXR™ Detector

Standard on every ISQ 7610 Single Quadrupole GC-MS System, the XLXR detector lasts eight times longer than its predecessor. By extending the time between replacement for preventative maintenance, running costs and obstacles to productivity are significantly reduced.

Advanced Electron Ionization (AEI) Source

The Thermo Scientific™ AEI source offers the ultimate in robust EI sensitivity, for reproducible low-level quantitation of target compounds in the most challenging matrices.

		Maintenance activity	
		Change column** (hrs: mins)	Exchange ion source (hrs: mins)
Standard GC-MS	Requires vacuum system venting and pump down operations	4:35	4:00
NeverVent	Venting and pump down not required	00:35	00:05
NeverVent time savings		87%	98%

**Includes conditioning

Compared to standard GC-MS technology, NeverVent technology offers substantial time savings when typical maintenance activities are performed.

Unstoppable sample throughput

Maximizing sample throughput is essential to producing results on time. The ISQ 7610 Single Quadrupole GC-MS System incorporates user-centric innovations that extend service intervals, reduce maintenance, and allow method consolidation to boost sample throughput while maintaining certainty in quality of results.

Intelligent instrument health monitoring

Knowing when to perform planned maintenance ensures that sample analysis is not interrupted due to a drop in instrument performance. The system's instrument health monitoring capability alerts users when to perform planned maintenance, avoiding unplanned maintenance and performance issues requiring sample reanalysis. Instrument health monitoring also facilitates maintenance record keeping so you can manage spare parts effectively to save time and reduce costs.

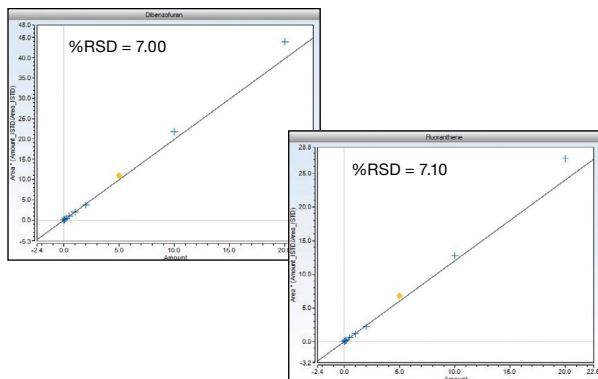

Examples of Average Response Factor calibration curve for PAHs with linearity that spans over 4 orders of magnitudes, from 2.5 to 20,000 ng/mL.

Consolidate methods

Running multiple calibration experiments for a single sample set adds extra time and effort to analytical workflows. The instrument's XLXR detector which is an electron multiplier detector extends dynamic range twofold compared to the previous design. Extended dynamic range capability enables labs to combine methods, including calibration curve development, allowing analysis of low- and high-concentration compounds in a single run.

Standard electron multiplier detection system

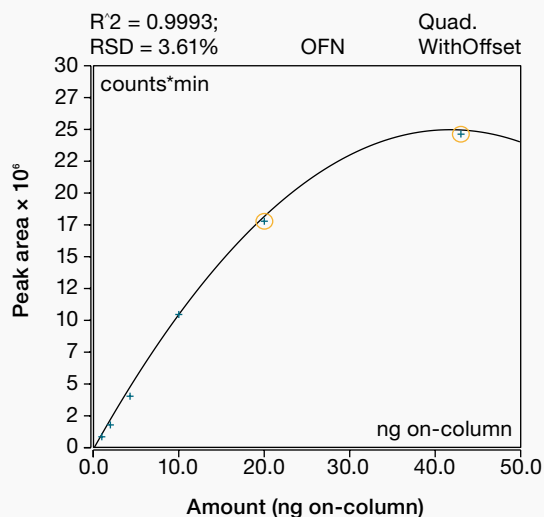

XLXR detector system

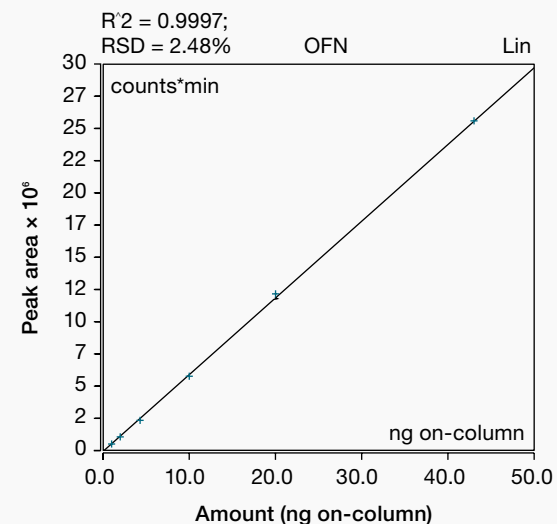

Comparison of the previous electron multiplier detection system and the XLXR detector system on the ISQ 7610 using OFN run in full scan mode over on-column range of 0.43 ng to 43 ng. The points marked by the yellow circles have shown detector saturation.

Unstoppable Return on Investment

Rapid instrument deployment reduces time to results and revenue generation. That's why the ISQ 7610 Single Quadrupole GC-MS System includes a comprehensive set of automated tools to provide users with a seamless experience when transitioning from other platforms, developing methods, and analyzing samples. This built-in intelligence reduces operator training needs and time to full productivity for rapid ROI.

AutoSIM

AutoSIM saves time and increases productivity by enabling users to acquire full-scan data, enter or import a list of target analytes from an external file (csv, Excel, LIMS database), and select SIM ions from full scan data in a guided, automated manner.

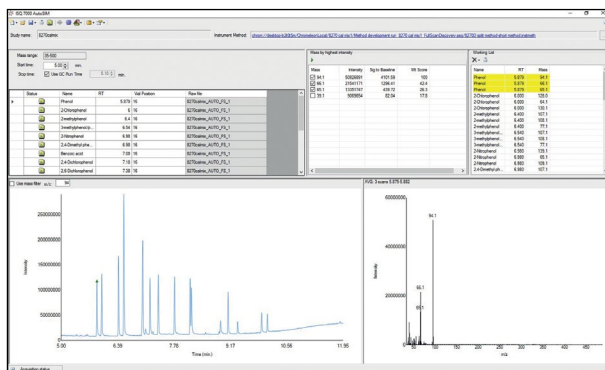

Timed-SIM

Timed Acquisition (t-SIM) assures maximum sensitivity for target compounds by automatically optimizing SIM quantitation dwell times for methods containing numerous analytes. T-SIM easily handles co-elution and ensures optimal instrument performance.

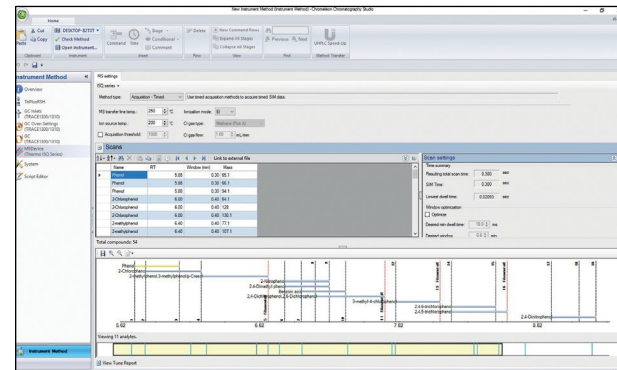

Full-scan acquisition

For untargeted analysis, full-scan acquisition methods offer quick and easy setup. Full-scan acquisition collects analytical information over the entire mass range, allowing verification of compounds using spectral library searches.

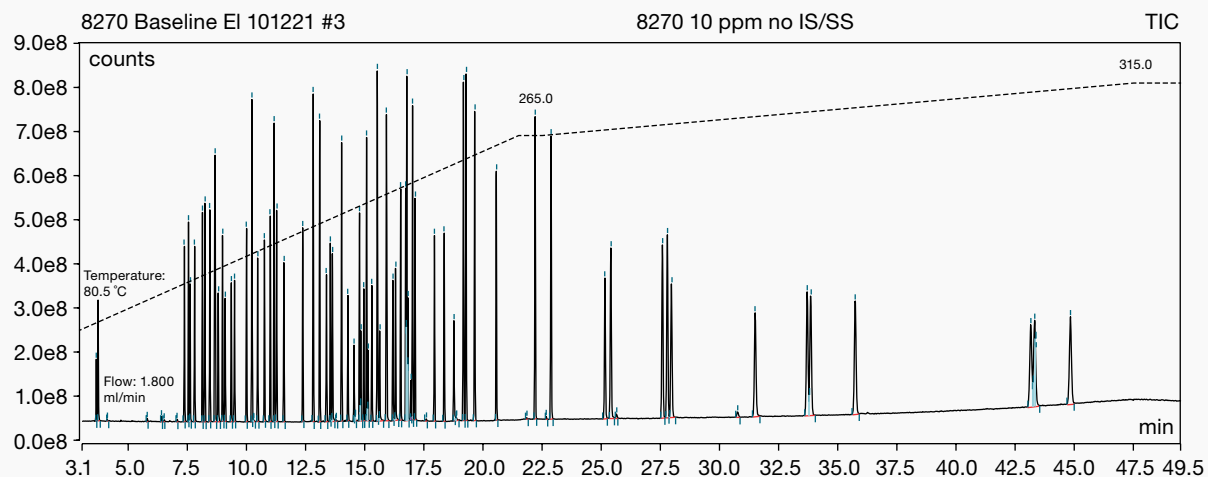

Full scan for EPA 8270 semi-volatile compounds at 10 ppm.

Retention Time Alignment

Column information (read only)

Carrier gas: He

Pressure units: kPa

Column length: 30.000 m

Column internal diameter: 0.250 mm

Film thickness: 1.00 μm

Precolumn installed

Precolumn length: 2.000 m

Precolumn internal diameter: 0.530 mm

Method information (read only)

Flow mode: Constant Flow

Flow: 1.800 ml/min

Oven temperature: 60 °C

Vacuum compensation

Actual column void time and reference retention time

Void time determination method: Measured

Theoretical void time: 1.021 min

Measured void time: 1.250 [0.001...1000.000 min]

Measured reference retention time (nC10): 9.000 [0.001...1000.000 min]

Target reference retention time

Target reference retention time (nC10): 9.000 [0.001...1000.000 min]

Calculated flow/pressure

Calculated flow (for method): 1.800 ml/min

Calculated pressure (information only): 117.696 kPa

Align method Cancel Help

Retention time alignment

Retention-time shifts due to changing the analytical column or performing maintenance should not result in missed compounds. The RTA tool maintains retention times while running everyday high-throughput GC-MS methods. If the column is changed or trimmed, the user simply provides the new column length and internal diameter or corrected pressure and flow values. RTA then uses the column's measured void time and the retention time of a reference substance to quickly realign the retention times of all the peaks in the chromatograms.

Mass spectral deconvolution

Unravel the heaviest co-elution in total ion chromatograms (TICs) by reconstructing clean mass spectra for individual compounds, making them ready for reliable library searching and confirmation.

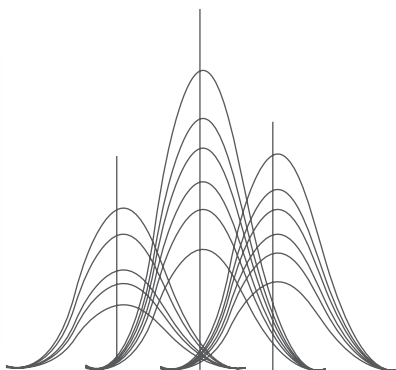

SmartTune

SmartTune eliminates the complexity associated with tuning, ensuring Thermo Scientific™ ISQ™ instruments are performing at required levels prior to running samples. A simple, guided interface efficiently checks and tunes the system, and intelligently eliminates any unnecessary steps in the process, resulting in faster tuning. If a problem is detected, SmartTune recommends the appropriate corrective action. SmartTune also provides user-customizable targets to facilitate consistent performance between analytical sequences.

In regulated environments, tuning methods must be included with the analysis for compliance. SmartTune can be operated in sequence for compliance, method flexibility, and to allow several analyses during one sequence.

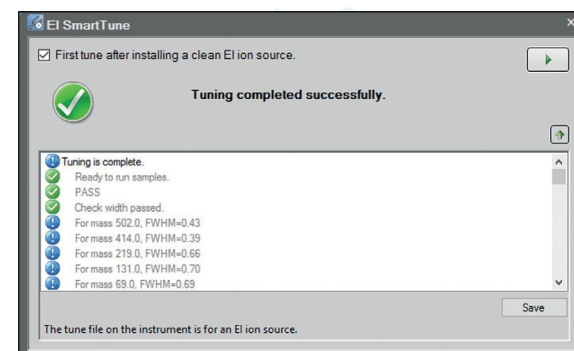
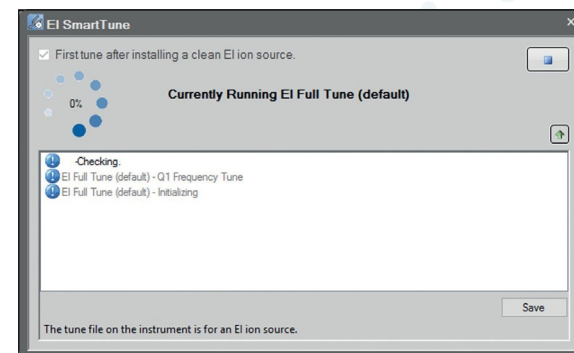

Unstoppable confidence in quantitative performance

Your GC-MS systems must provide the sensitivity, speed, and reproducibility required to carry out regulated methods consistently and efficiently, day after day. The ISQ 7610 Single Quadrupole GC-MS System delivers sensitive and reproducible analysis for a broad range of quantitative workflows.

Meet sensitivity requirements

Laboratories expect their GC-MS instruments to deliver the sensitivity required to meet the toughest analyses and regulations, today and in the future. When equipped with the ExtractaBrite source, the ISQ 7610 Single Quadrupole GC-MS System can consistently perform low-level quantitative analyses. For ultra-trace quantitation, the AEI source can be chosen to reach attogram-level detection limits, allowing you to confidently exceed regulatory requirements.

Unstoppable reproducibility

Being able to meet the regulatory limits is not enough. An instrument must produce consistent results at these limits, day after day. In either ion source configuration, the ISQ 7610 Single Quadrupole GC-MS System produces robust, best-in-class results. Compared to other systems, the instrument can analyze substantially more samples before routine maintenance is needed, maximizing throughput and efficiency.

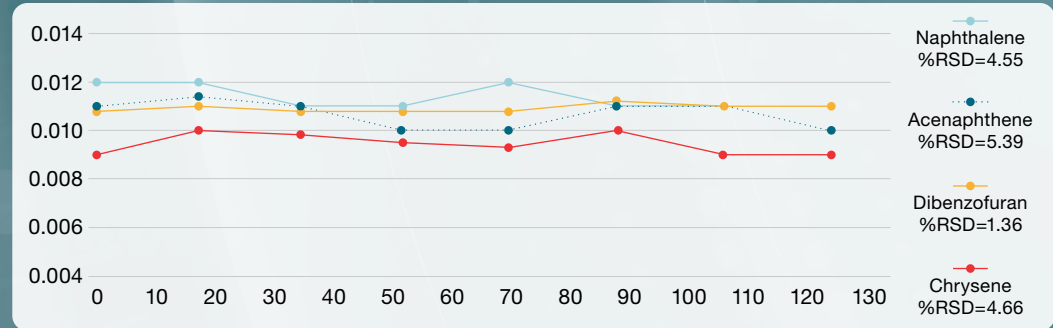

Calculated value of PAHs in QC water at 0.01 ppm over 130 injections

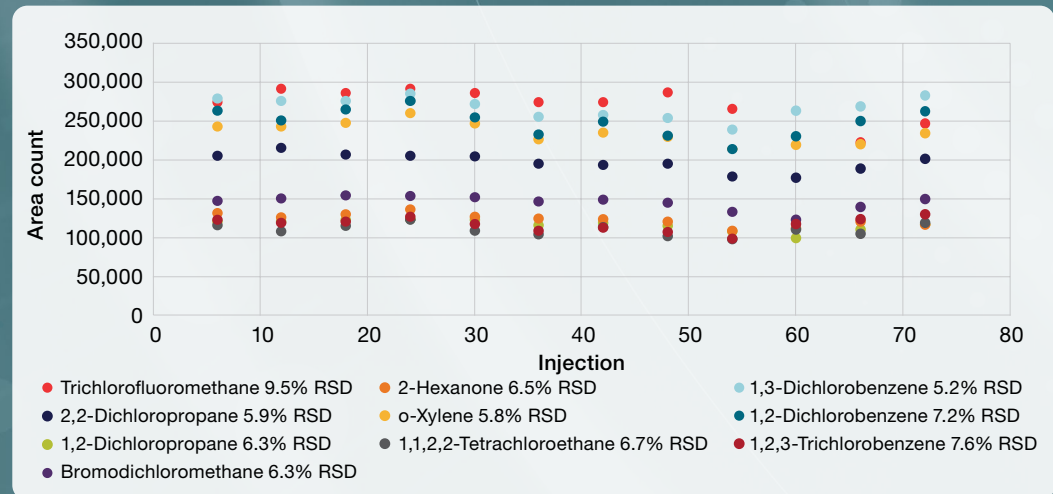

Repeatability (absolute peak area) of 12 QC 20 ppb soil standards assessed at regular intervals over n=77 consecutive injections corresponding to 2 days of analysis analyzed with the ISQ 7610 coupled with the Atomx XYZ purge and trap.

Unstoppable GC-MS technology

Thermo Scientific offers a portfolio of GC-MS systems to address your applications needs. Combined with productivity-enhancing software, these advanced systems enable you to meet or exceed the most stringent requirements for performance, reliability, and value.

TSQ 9610 Triple quadrupole GC-MS/MS System

If increased selectivity and sensitivity are required, the Thermo Scientific™ TSQ™ 9610 Triple Quadrupole GC-MS/MS system provides high-speed, high-capacity MS/MS selected reaction monitoring (SRM) for quantitation of target compounds in complex matrices.



Orbitrap Exploris GC mass spectrometers

For targeted or unknown compound identification in complex sample matrices, Thermo Scientific™ Orbitrap™ Exploris™ GC mass spectrometers provide high-resolution accurate-mass (HRAM) data with sub-ppm mass accuracy. Acquire full-scan data for targeted and untargeted screening, confirmation, unknown identification, quantitation, and retrospective analysis.



Unstoppable confidence in your future

To ensure you are ready for any analytical challenge, the ISQ 7610 Single Quadrupole GC-MS System is fully upgradable from entry-level to advanced configurations. Now you can be confident that your laboratory can adapt to new challenges using the same investments in GC-MS technology. Select from five levels of performance with field-upgradeable options. All configurations are based on the user-centric ISQ single quadrupole design with easy-to-use tools such as SmartTune, AutoSIM, and t-SIM that facilitate adoption and method setup.

**ISQ 7610 NO VPI
ExtractaBrite Small
Turbo Pump**



**ISQ 7610 NO VPI
ExtractaBrite**



**ISQ 7610 VPI
ExtractaBrite**



**ISQ 7610 VPI
ExtractaBrite + CI**



**ISQ 7610 NO VPI
AEI Source**



Upgrade-ability pathway

ISQ 7610 GC-MS system configurations

Choose from five levels of ISQ 7610 Single Quadrupole GC-MS System performance with field-upgradeable options

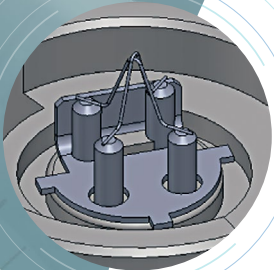

Unique dual-filament design

The ISQ 7610 GC-MS system offers a dual filament for extended operation and lifetime. The unique design of the filament ensures that both filaments offer similar analytical performance. The filaments are oriented in the same direction for improved performance and are protected by an electron lens. Your analyses do not pay a price for switching from one filament to the next.

Enhanced transfer line design

The ISQ 7610 GC-MS system features an optimized GC-MS interface. This transfer line evenly distributes heat across the length of the analytical column, ensuring that there are no hot or cold spots, which in turn ensures Gaussian peak shapes, even for high-boiling compounds.

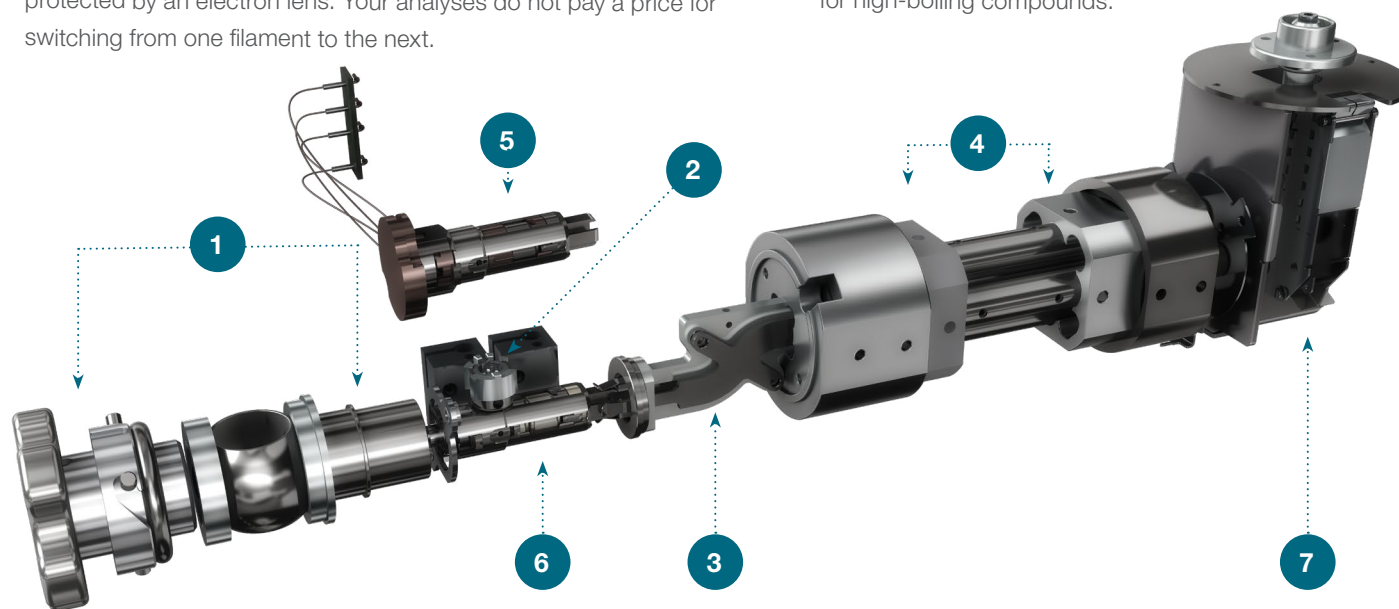

1 Optional Vacuum Probe Interlock (VPI) enables NeverVent technology.

2 Unique Dual Filament design for extended operation and lifetime.

3 S-shaped ion guide for off-axis ion optics, eliminates neutral noise.

4 Solid, homogeneous non-coated, non-heated maintenance-free quadrupole.

5 Advanced Electron Ionization (AEI) source achieves ultimate sensitivity and robustness through a tightly controlled ion beam. Featuring RF lens technology. Available in a dedicated configuration.

6 High sensitivity ExtractaBrite ion source, featuring patented RF lens ensuring system matrix robustness. Part of the NeverVent system: removable under vacuum.

7 Triple off-axis XLXR detection system, with off-axis 10 kV dynode, discrete dynode electron multiplier and electrometer with high linear range.

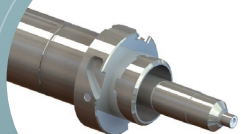

A

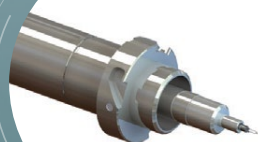

B

Optional A) Direct Insertion Probe (DIP) and B) Direct Exposure Probe (DEP). The DIP can be used for rapid analysis of solid matrices and features slow volatilization with a heated capillary tube. The DEP features a heating filament for rapid molecular weight confirmation of solids dissolved or suspended in a suitable solvent.

Unstoppable confidence with a GC always ready to run

Designed for a new level of usability and uptime the Thermo Scientific™ TRACE™ 1600 Series Gas Chromatograph (GC) delivers measurably more productivity and lower costs. With a unique modular design and plug-and-play injectors and detectors, you have full flexibility to perform maintenance offline and use different configurations on the same GC to make the most of your GC-MS system. When combined with the Thermo Scientific™ AI/AS 1610 Liquid Autosampler, the system provides easy and reliable automated sample injection to meet any sample-throughput demand.



Full range of self-installable injector and detector modules to minimize GC downtime.



Instrument health icon is always visible on the GC touchscreen to alert users to maintenance needs.

High-resolution touchscreen to support daily operations with video instruction that walks through common procedures.



Simplify and speed up column installation with quick, easy, and safe tool-free column lock connectors with the ability to work comfortably in an illuminated oven.



Easily add robust, unattended sample injection to increase sample throughput, enabling simultaneous analysis into two channels with the Gemini configuration.



Minimize downtime

Automated GC consumables tracking with alerts minimizes unexpected downtime and waste due to unnecessary replacement. Instrument health is on continuous display on the touchscreen. Tubing-free injectors design allows for easy and quick septum/liner replacement, simplifying routine maintenance operations.



Perform maintenance offline

Unique Thermo Scientific™ iConnect™ injector and detector modules can be kept as interchangeable spares, allowing analyses to continue while deeper maintenance is performed offline. Simple replacement of self-installable components facilitate as well troubleshooting operations, saving time and money.



Increase laboratory efficiency

Versatile modular configurability minimizes idle time, maximizing the productive use of your laboratory's GC systems. The suite of iConnect injectors and detectors can be shared among multiple GC systems in numerous configurations without installation costs.



Save time with robust unattended operation

The slide-in self-aligning AI/AS 1610 Liquid Autosampler provides reliable unattended sample analysis, saving valuable time and increasing productivity while improving data quality with high-precision injections.



Add the productivity of robotic sample handling

The Thermo Scientific™ TriPlus™ RSH SMART autosampler offers advanced robotic sample handling to extend automation beyond liquid, headspace, and solid phase microextraction (SPME). Your results will benefit from improved precision and reproducibility, while your laboratory will increase productivity with flexible sample handling and automated sample preparation procedures, such as dilution, internal standard addition, and derivatization workflows.

Add robust headspace injection

For volatiles analyses, the Thermo Scientific™ TriPlus™ 500 Headspace (HS) Autosampler offers reliable and robust unattended operation in 12-, 120-, and 240-vial configurations. Valve-and-loop technology and direct column connection ensure the highest level of performance to facilitate compliance in regulated environments. It can be mounted with the AI/AS 1610 Liquid Autosampler for an all-in-one configuration.

Use third-party devices with ease

For more analytical versatility, the TRACE 1600 Series GC is compatible with the most advanced Markes International thermal desorption (TD) and Teledyne Tekmar purge and trap (P&T) solutions.



TD is a pre-concentration technique for the GC analysis of volatile and semi-volatile organic compounds (VOCs) in solid, liquid, or gas samples. Markes International TD platforms offer solutions for sorbent tubes, online samples, canisters, and bags.

Purge and Trap devices concentrate and prepare soil and water samples for GC-based environmental testing of VOCs. The Teledyne Tekmar P&T allows precise and automated sample preparation, offering full compliance with EPA methods.



thermo
scientific

The TriPlus RSH SMART Autosampler delivers exceptional precision, flexibility, and productivity with robotic sample handling. The SMART technology permits usage tracking of syringes and SPME/SPME Arrow fibers for enhanced GLP compliance.

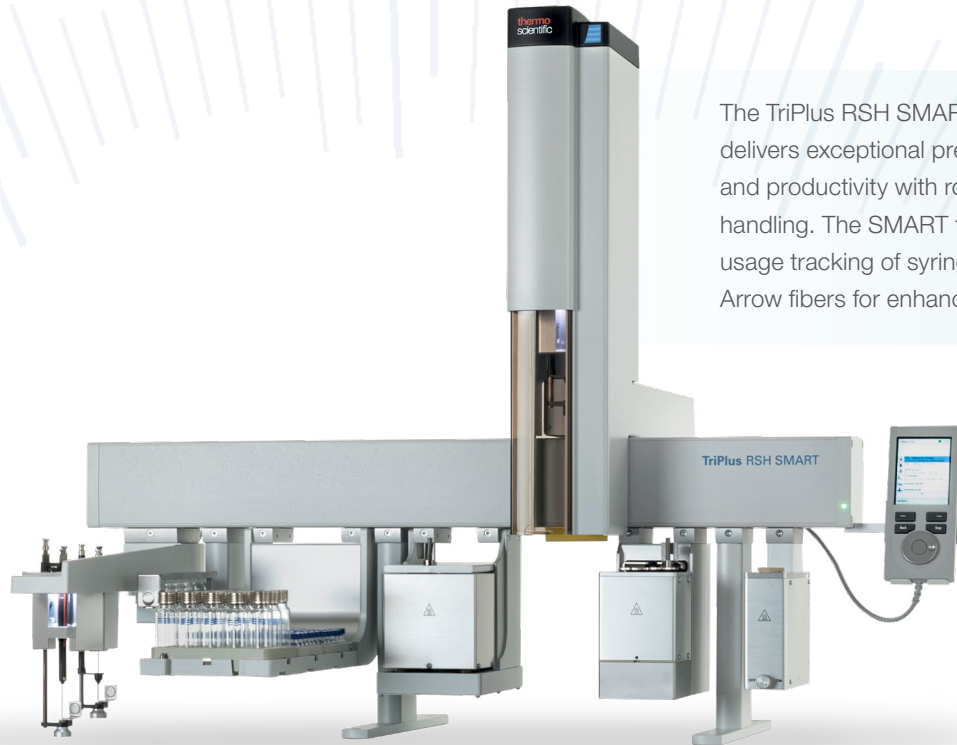

TriPlus 500 HS Autosampler, available in 12-, 120-, and 240-vial configuration, combines longer unattended operations with utmost precision of the analytical results.



The right choice for any workflow

The ISQ 7610 Single Quadrupole GC-MS System can be implemented seamlessly into any laboratory workflow to increase efficiency. Navigate your most difficult analytical challenges and easily obtain results with automated workflows and simplified operation.



Food safety



Environmental



Petrochemical



Clinical and toxicology

Preserve a clean and safe environment

Analysis of air, water, and soils for the presence of volatile and semivolatile organic contaminants is essential to preserving a clean and safe environment. The consistent quantitative performance of the ISQ 7610 Single Quadrupole GC-MS System provides confidence in results with increased uptime and sample throughput.

The TRACE 1600 Series GC can be coupled with sampling solutions like Purge and Trap, Thermal Desorption, and pyrolysis to analyze a breadth of environmental samples. These sampling solutions are fully controlled in Thermo Scientific™ Chromeleon™ Chromatography Data System (CDS) software, facilitating compliance and ensuring confidence in results. For U.S. EPA-based environmental applications, the Environmental Analysis Extension Pack available in our AppsLab method library provides a comprehensive set of GC-MS e-workflows and reporting templates.

Ensure food quality

Ensuring the consistency of foods by identifying any anomalies from batch-to-batch is an imperative for food manufacturing. When operated in the full-scan or targeted SIM modes, the ISQ 7610 Single Quadrupole GC-MS System is ideally suited to food quality monitoring. Robust, reproducible quantitation, best-in-class sensitivity, and high sample throughput provide unprecedented efficiency and confidence in results.

Characterize green energy sources

Characterizing renewable sources of energy to ensure they are free of unwanted byproducts is key to a greener future. The ISQ 7610 Single Quadrupole GC-MS system is highly adaptable to the analysis of numerous matrices, including direct analysis of fuel sources for quality verification purposes.

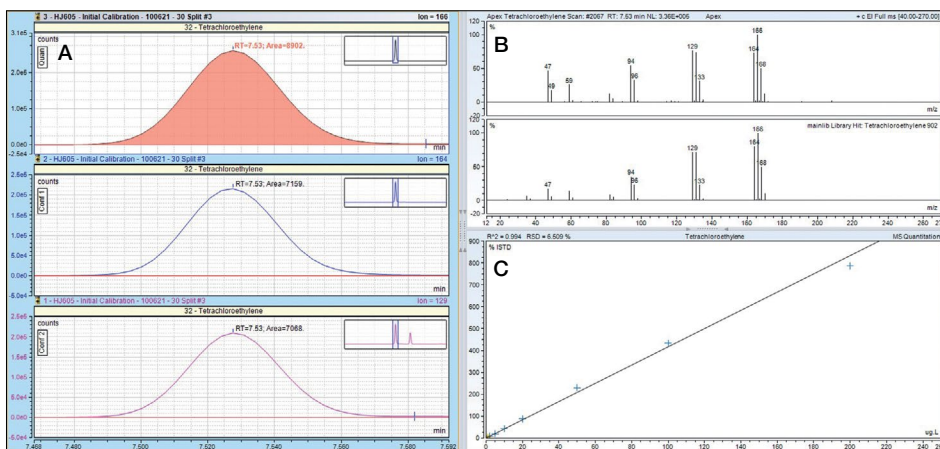

Analysis of tetrachloroethylene in soil showing Chromeleon results browser displaying extracted ion chromatograms in the 1 ppb water standard (A), a matching measured spectrum to the NIST library (B) and a linear calibration over a concentration range of 1 ppb to 200 ppb (C).

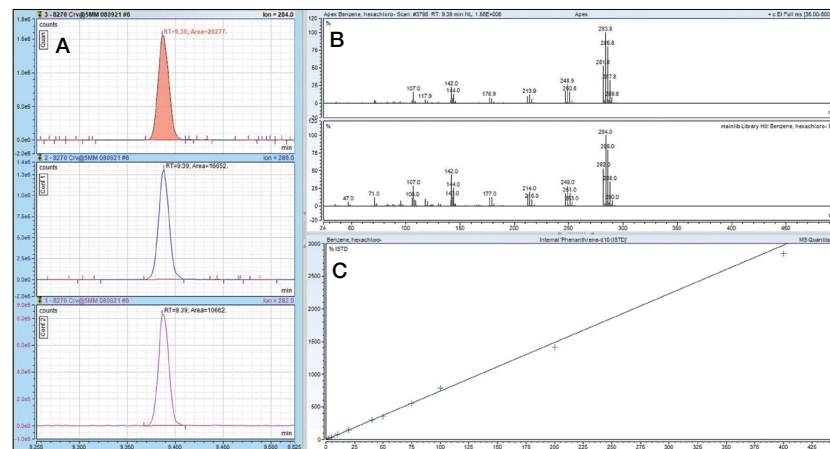

Analysis of hexachlorobenzene showing Chromeleon results browser showing extracted ion chromatograms in the 100 ppb standard (A), a matching measured spectrum to the NIST library (B) and a linear calibration over a concentration range of 100 ppb to 40,000 ppb (C).

Companion software for the ISQ 7610 Single Quadrupole GC-MS System

Integrated workflow-driven software, application library, and support streamline your applications and everyday tasks including:

- Instrument optimization and troubleshooting
- Method development and implementation
- Reporting results



Thermo Scientific™ Chromeleon™ software

Enterprise-level instrument control, data processing, and ability to address any regulatory requirement.



Thermo Scientific™ TraceFinder™ software

Comprehensive quantitative workflows for all applications—from method development to report generation.



AppsLab method library

A comprehensive repository for application-specific methods, data sets, and application notes. For environmental GC-MS applications, the Environmental Analysis Extension Pack provides a comprehensive set of over 30 predefined templates for calculating results and generating reports that are compliant with US EPA requirements.



Service and support

Our global Centers of Excellence, in-your-lab training using your methods, and AppsLab Library of Analytical Applications ensure your success.

Everything you need at your fingertips

Easy, reliable, and innovative, application-focused GC columns and consumables

Whether you are performing analysis in pharmaceutical, forensics/toxicology, environmental, food, petrochemical, or general analytical industries, we offer a wide range of vials, syringes, septa, liners, columns, gas filters and accessories designed to complement our GC and GC-MS systems and autosamplers in application-focused solutions.

Because time is valuable, the consumables you need for everyday workflows are available for easy online ordering and reordering, with pricing and stocking information, fast shipping, and status tracking.

- Low-bleed, high-reproducibility Thermo Scientific™ TraceGOLD™ columns
- Consumables tested and certified on TRACE 1600 Series Gas Chromatograph systems
- Vials and syringes guaranteed for use with Thermo Scientific autosamplers
- Thermo Scientific™ GFM Pro Gas Flowmeter and Thermo Scientific™ GLD Pro Gas Leak Detector for system installation and maintenance
- Derivatization reagents and derivatization-grade solvents

Order at thermofisher.com/chromatographyconsumables

Find out more at thermofisher.com/ISQ7610

For Research Use Only. Not for use in diagnostic procedures. © 2022 Thermo Fisher Scientific Inc. All rights reserved. All other trademarks are the property of Thermo Fisher Scientific and its subsidiaries unless otherwise specified. **BR000162-EN 0322C**

