

Plynová chromatografie od FID po Orbitrap



Magdalena Voldřichová

pragolab

Thermo
SCIENTIFIC

Iontová Chromatografie



- Absolutní jednička na trhu
- Kapilární i standardní systémy
- **Chromeleon**

Kapalinová Chromatografie



- Nejširší aplikační záběr
- Ultra HPLC nejvyšší třídy i standardní systémy
- **Chromeleon**

Plynová Chromatografie



- Flexibilita – výměnné moduly
- Špičková GC-MS technika
- **Chromeleon**

Nabídka



TRACE 1300



NEW



Patent Pending



Helium saver modul

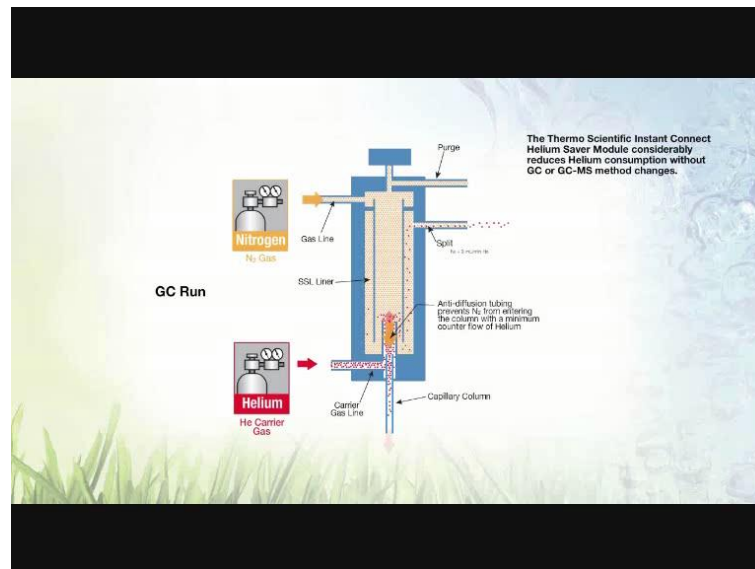
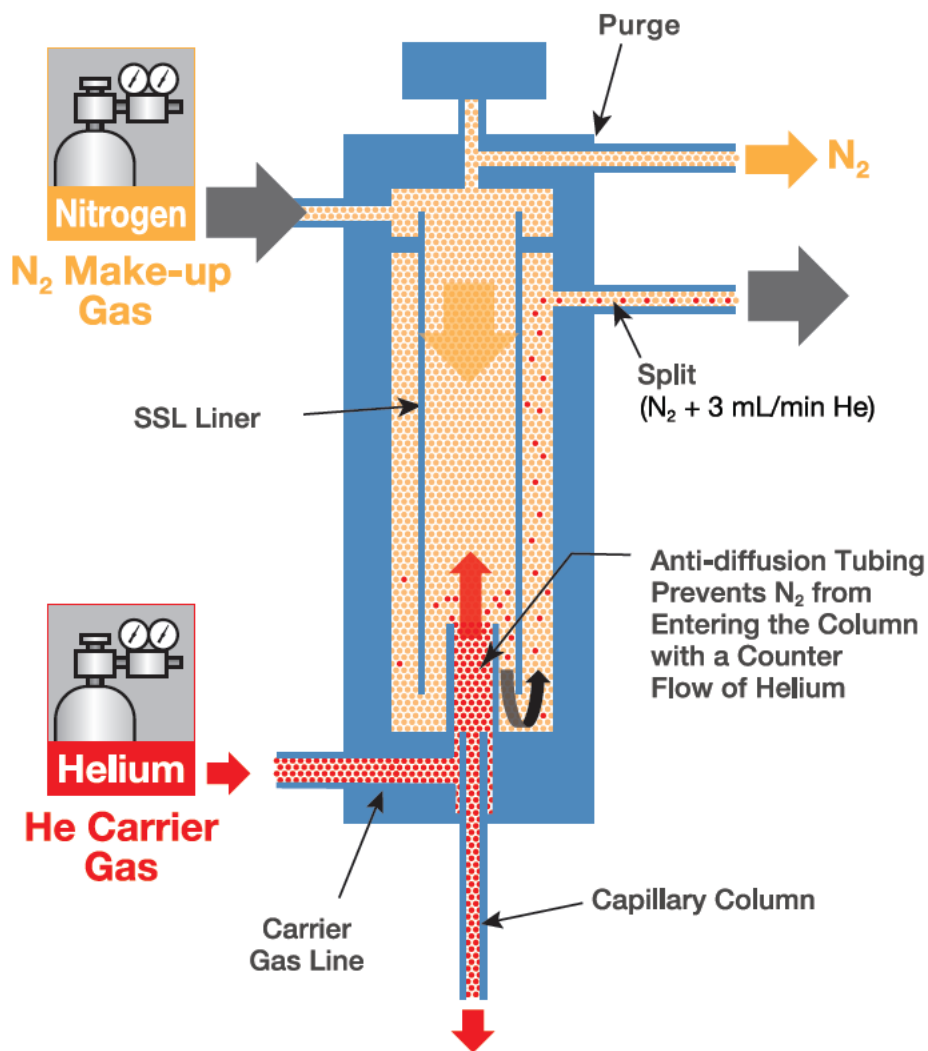

Helium Saver Extends the Lifetime of the Helium Cylinder

- 3.5 years continuously used 24/7/365 for GC-MS analysis
- 5.4 years shutting helium off or to N₂ during weekends
- 10.5 years shutting helium off or to N₂ overnight (8 hr day)
- 14.6 years shutting helium off or to N₂ on weekends and overnight

This could be the **last and only** helium cylinder that will be needed for the lifetime of the instrument



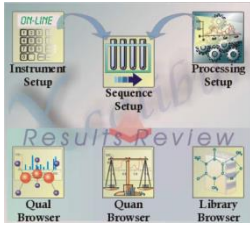

HRMS-orbitrap

QqQ



Q



Chromeleon

Jednoduchý kvadrupol



ISQ QD

Single Quadrupole Mass Spectrometer



ISQ LT

Single Quadrupole Mass Spectrometer



Chromeleon

TraceFinder



Iontový zdroj

Výměna a čištění iontového zdroje
bez nutnosti porušení vakua



00:20

Thermo
SCIENTIFIC

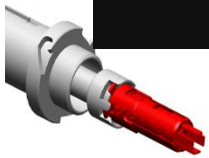

Vyjmutí iontového zdroje



DIP/DEP Sony

C:\Documents and Settings...

3/22/2010 5:07:52 PM

Direct Probes sondy *ISQ LT*

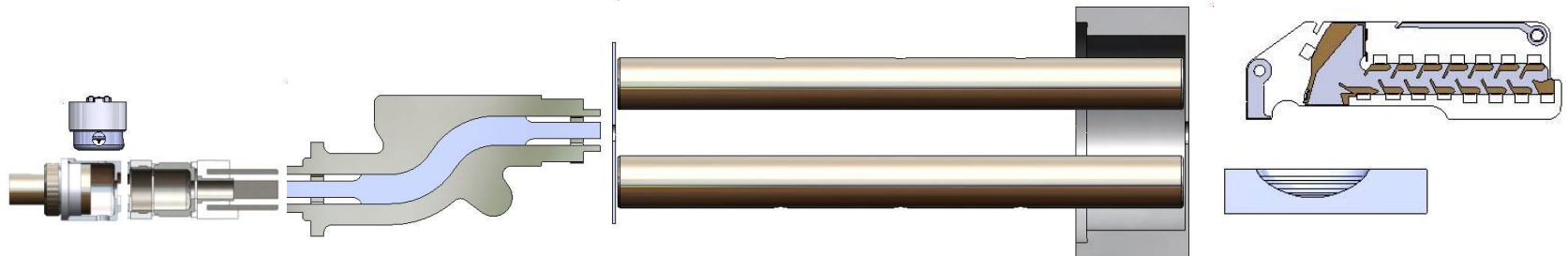
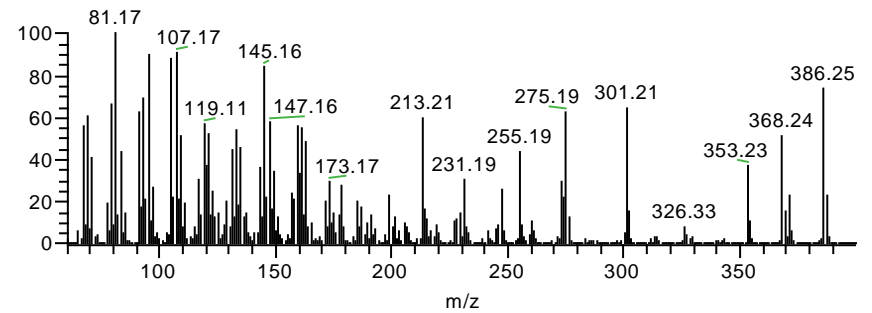
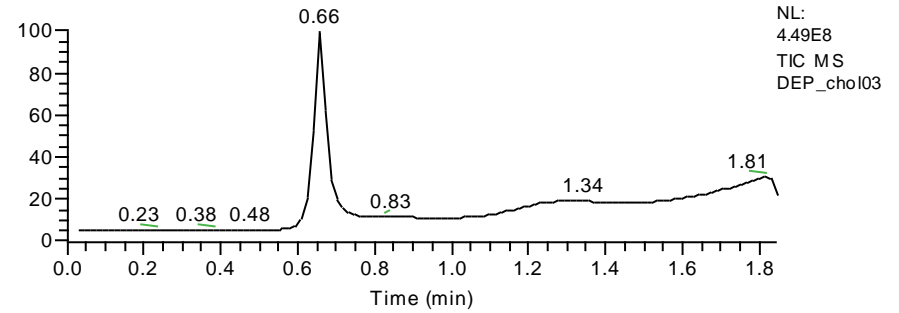
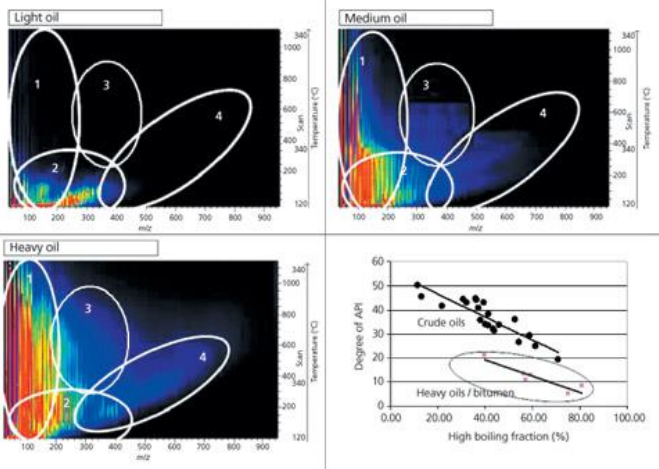

Nový trojitý kvadrupol



QqQ systém pro cílenou analýzu

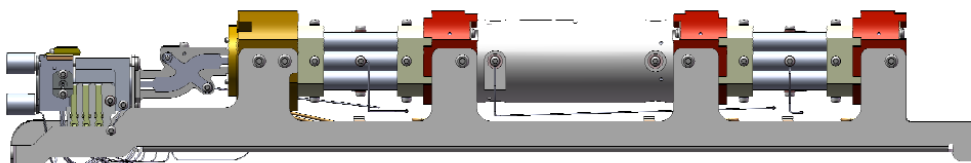
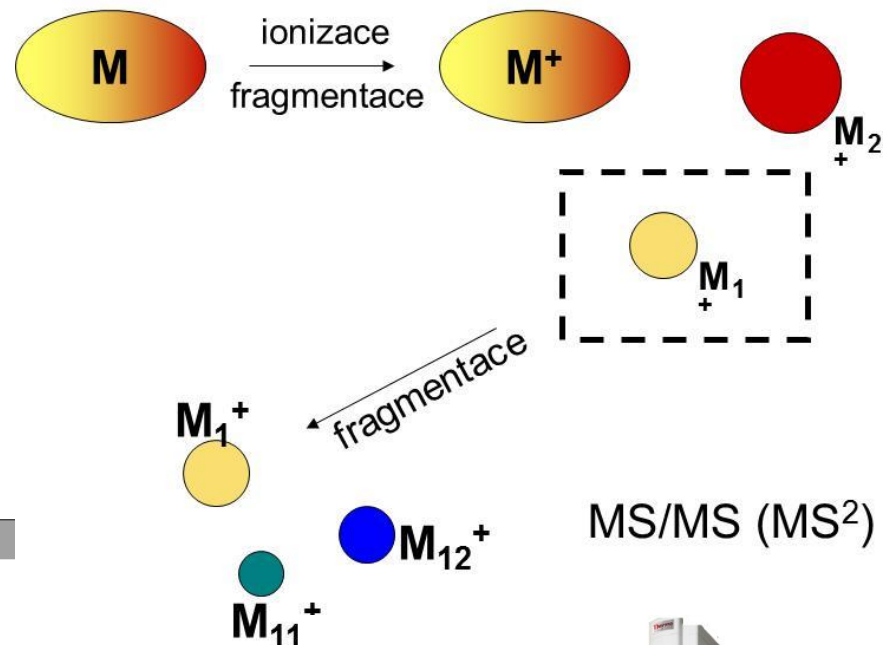

TSQ 8000 Evo

Robustness Cold Pressed Orange Oil (external standard calibration)

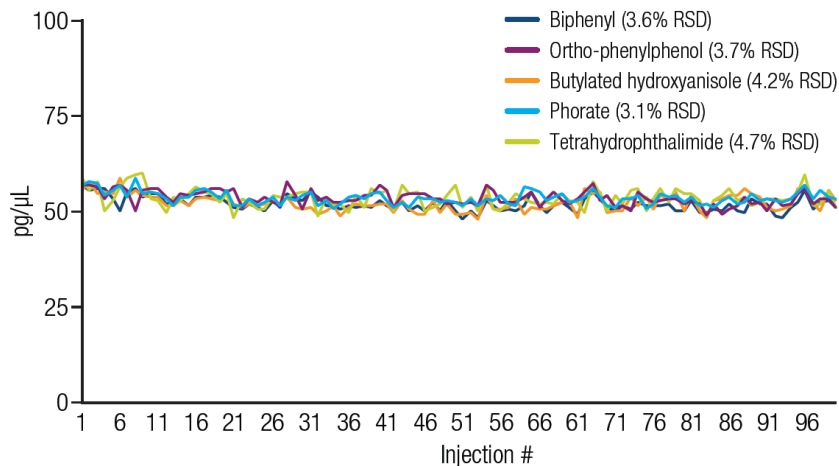

ExtractaBrite Source



Thermo
SCIENTIFIC

QqQ SYSTEM TSQ 8000 Evo



Enhanced Velocity Optics

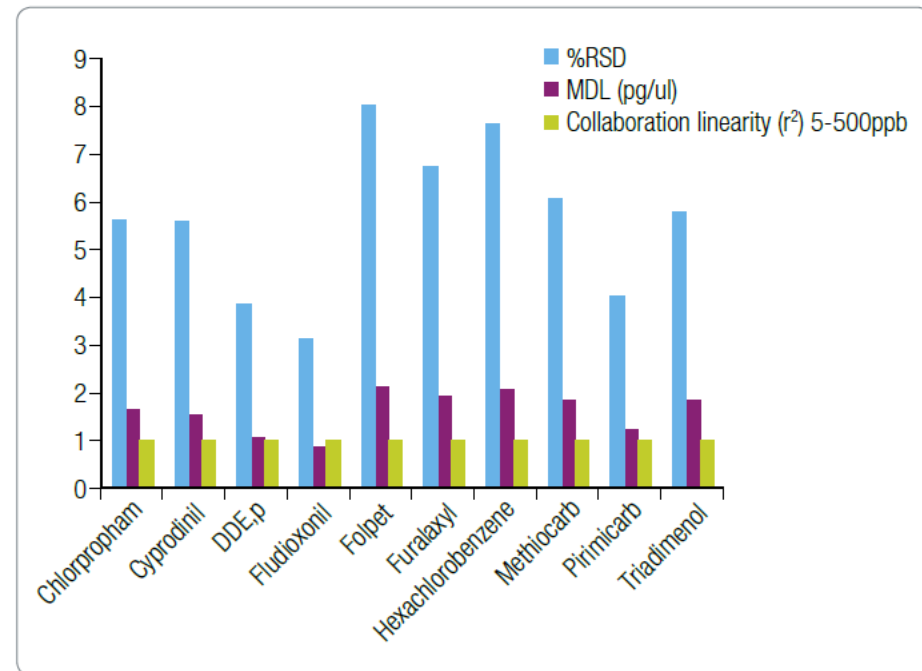
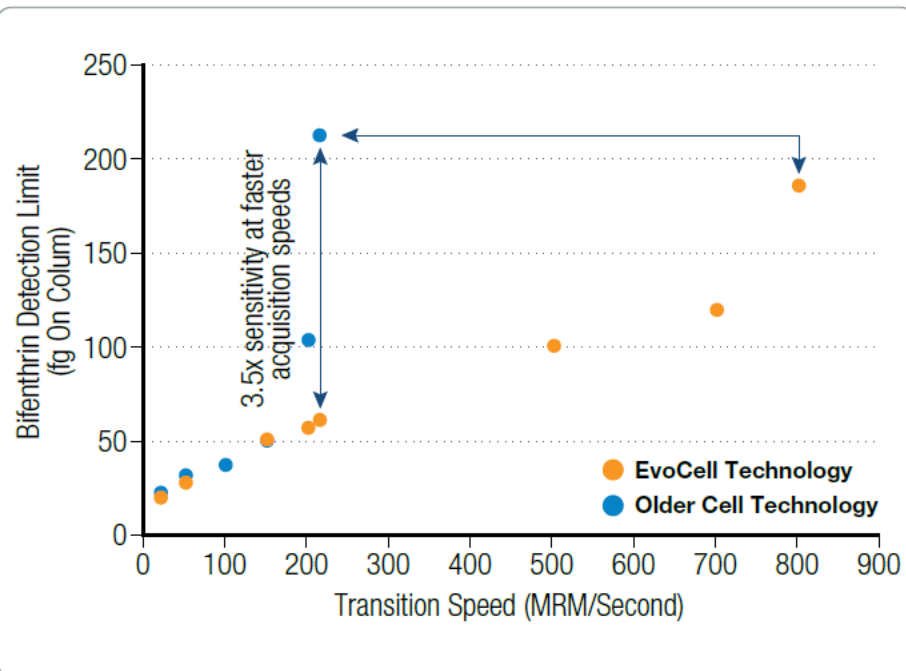

Pittcon 2015 – GC Orbitrap

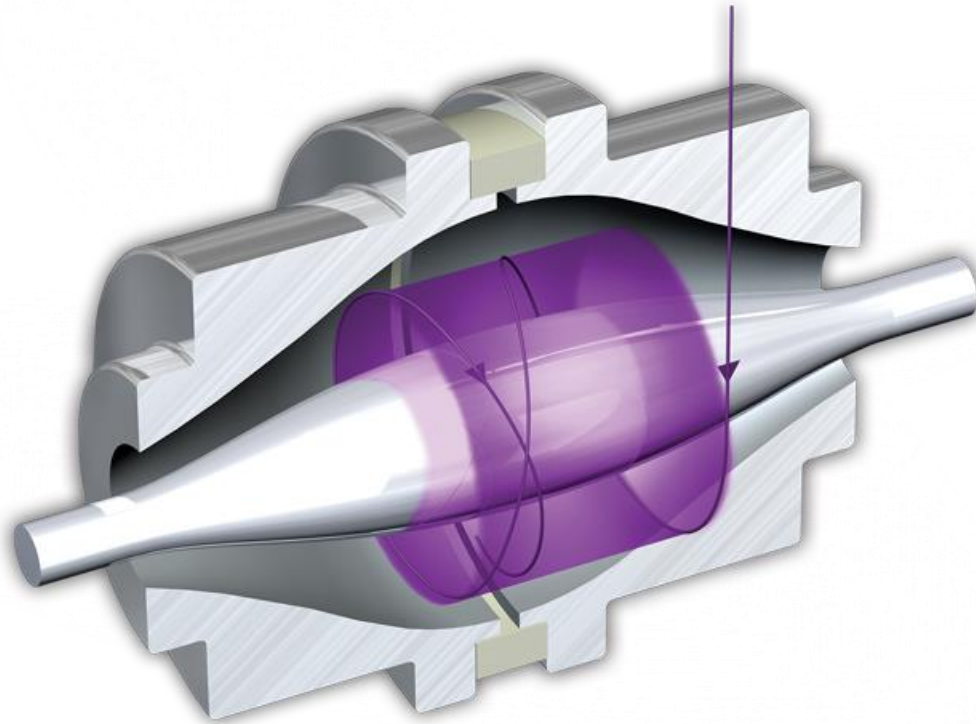

Jak pracuje?

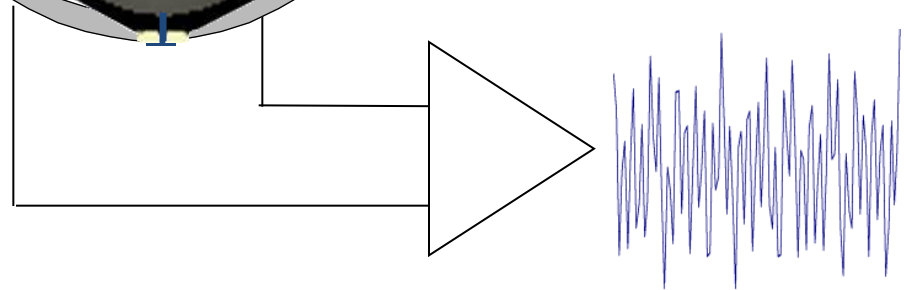
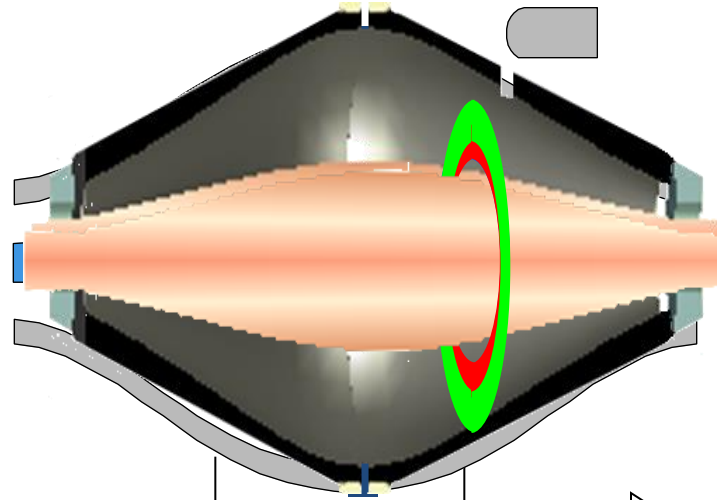
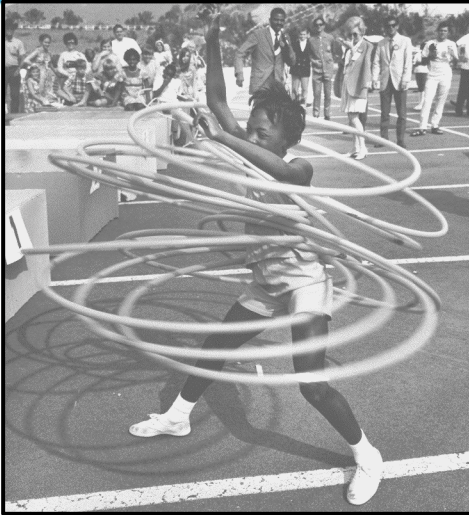

- ionty v orbitrapu generují komplexní signál, který je zpracován pomocí Fourierovy transformace

Průlom v GC-MS

Maximální selektivita

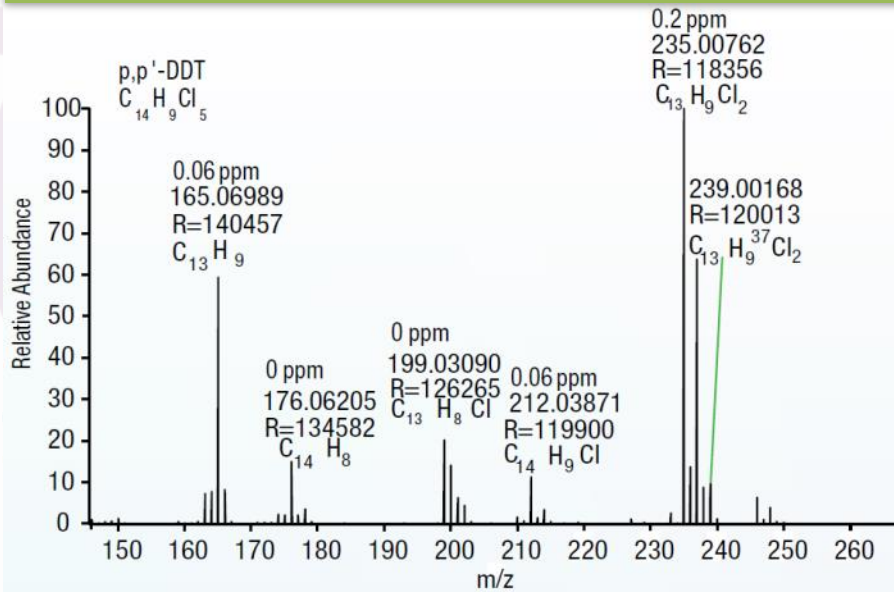

- až 120k @ m/z 200
- Skvělá selektivita v komplexní matici
- Vysoké rozlišení
- Rychlé skenování

Průlom v GC-MS

Vysoká selektivita

Rychlý sběr dat

- důležité pro přený popis píku
- Full scan s rozlišením 60 (FWHM @ m/z 200) - **17 scans na pík**
- Dostatečná rychlost pro GC!

XIC of dieldrin in baby food (m/z 262.85642) 100ppb

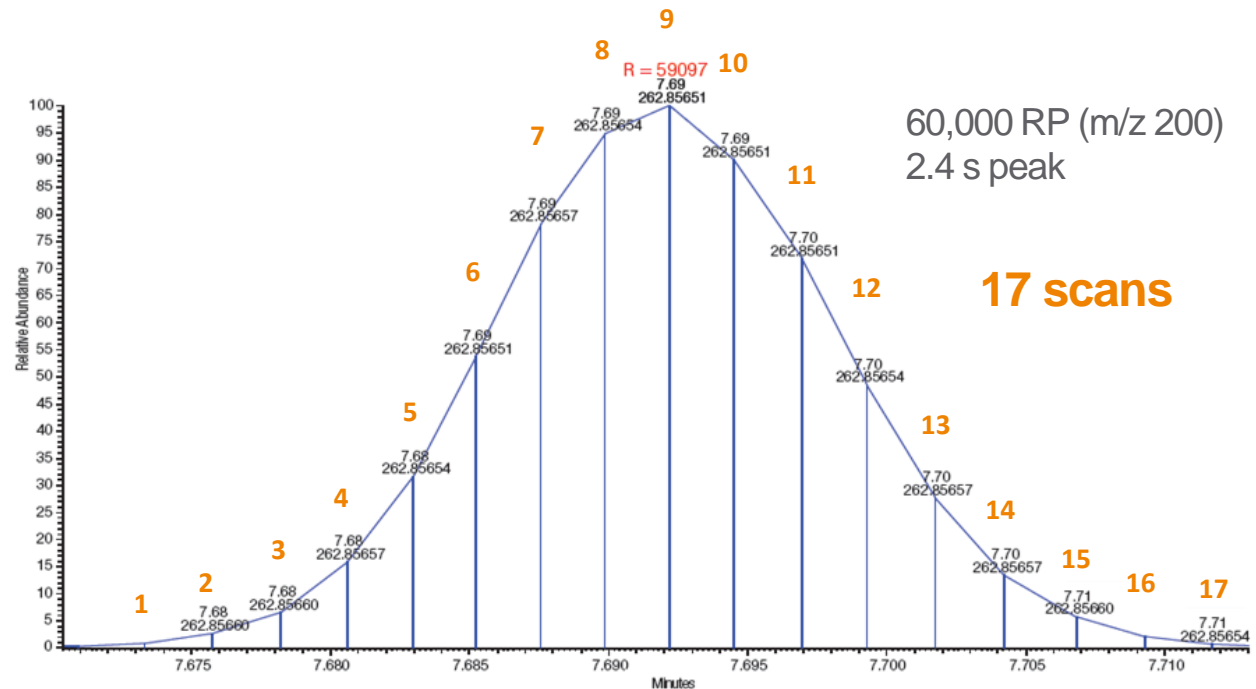

Průlom v GC-MS

Vysoká selektivita

Chlorprophram

- 10 ng/g QuEChERS extract of leek
- Full scan s rozlišením >30k (FWHM @ m/z 200) – detekce bez interferencí
- Skvělá přesnost hmoty

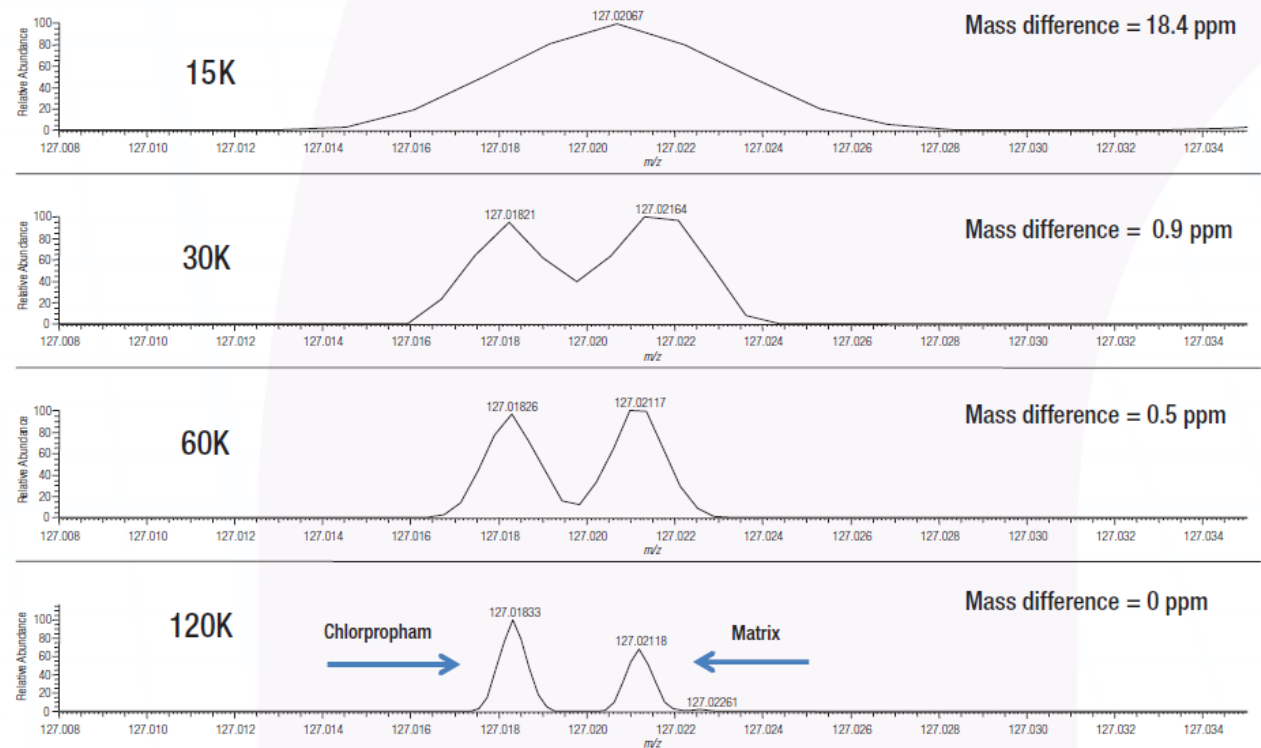

Bez rušení vakua

CHEMICKÁ IONIZACE



Výměna iontového zdroje do 2 minut

...



Thermo Scientific Q Exactive GC Hybrid Quadrupole-Orbitrap GC-MS/MS System

Unprecedented Depth in GC-MS Analysis





Děkuji za pozornost!