

The IonPac CS5A is a high resolution ion-exchange column for the determination of transition and lanthanide metals. The MetPac PDCA and Oxalic Acid Eluent Concentrates are ready-to-dilute reagents that improve ease-of-use and ensure eluent consistency. The MetPac PAR Postcolumn Reagent Diluent provides simple postcolumn reagent preparation. Together, the IonPac CS5A and MetPac reagents provide a complete, targeted solution for transition metals analysis.

Now sold under the
Thermo Scientific brand

Thermo
SCIENTIFIC

Rapid, Routine Analysis of Transition Metals in Diverse Samples

The IonPac CS5A cation-exchange column permits the simultaneous determination of common transition metals in less than 11 minutes using a unique bifunctional pellicular resin (see Figure 1). Transition metals are detected following complexation with 4-(2-pyridylazo) resorcinol (PAR), the postcolumn reagent. The resulting PAR

derivative is detected at 520–530 nm. Lanthanides can also be determined using the IonPac CS5A with an oxalic acid/diglycolic acid eluent (see Figure 2). Acidic samples, including acid digested samples, can be injected without neutralization (see Figure 3).



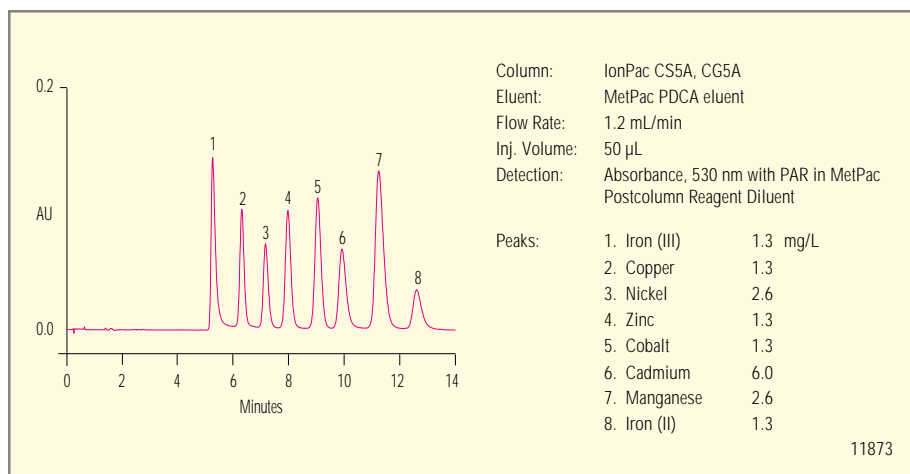

Figure 1. Separation of transition metals by anion exchange using the MetPac PDCA Eluent Concentrate. The postcolumn reagent, 4-(2-pyridylazo) resorcinol, is delivered using the PC10 Postcolumn Delivery System.

Two Eluent Concentrates for Maximum Flexibility

Ready-to-dilute eluent concentrates are available to easily optimize the IonPac CS5A selectivity for a range of applications. The MetPac PDCA eluent uses pyridine-2,6-dicarboxylic acid as a strong complexing agent that separates the metal complexes by anion exchange. PDCA eluent is best suited for the separation of iron (II) and iron (III), copper, nickel, zinc, cobalt, cadmium, and manganese (see Figure 1).

The MetPac Oxalic Acid eluent uses oxalic acid as a moderate-strength complexing agent to separate metals by a mixed mode mechanism. The oxalate eluent separates lead, copper, cadmium, cobalt, zinc, and nickel (see Figure 4).

Easy-to-Use Postcolumn Reagent

The MetPac PAR Postcolumn Reagent Diluent is ready to use as a diluent for 4-(2-pyridylazo) resorcinol. The PAR Diluent has controlled pH and low metal contamination to ensure reliable and convenient preparation of the PAR postcolumn reagent. This reagent, added through a mixing tee, reacts with a wide range of metals and offers detection limits in the low μ g/L (ppb) range (see Figure 5).

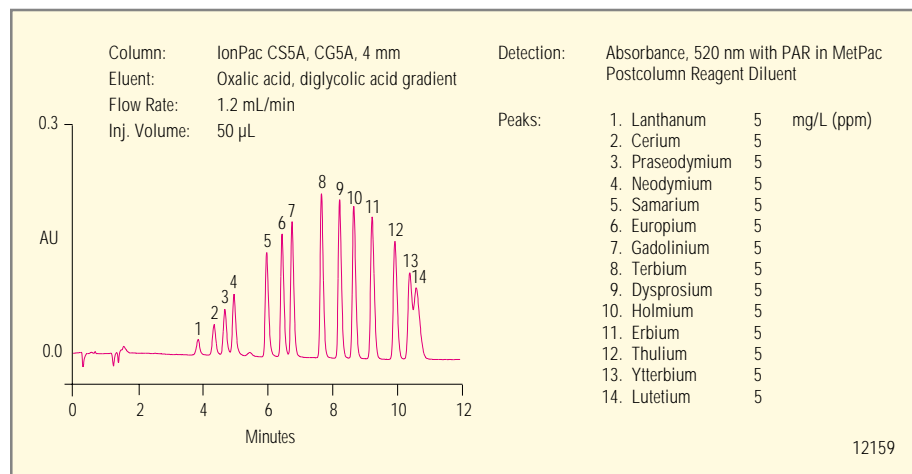

Figure 2. Separation of lanthanide metals using oxalic acid/diglycolic acid as the complexing agent.

Rugged, Reliable Analyses with Guaranteed Performance

The polymeric IonPac CS5A has a highly crosslinked structure to ensure a long column life and effective column cleanup.

The entire manufacturing process, including resin synthesis and packing of the chromatography columns, is carefully controlled in the Dionex ISO 9001-registered facility to ensure that every IonPac CS5A column delivers reproducible performance. Only reagents with the lowest metal contamination available are used to produce the MetPac reagent products. All IonPac and MetPac products are tested to ensure lot-to-lot performance.

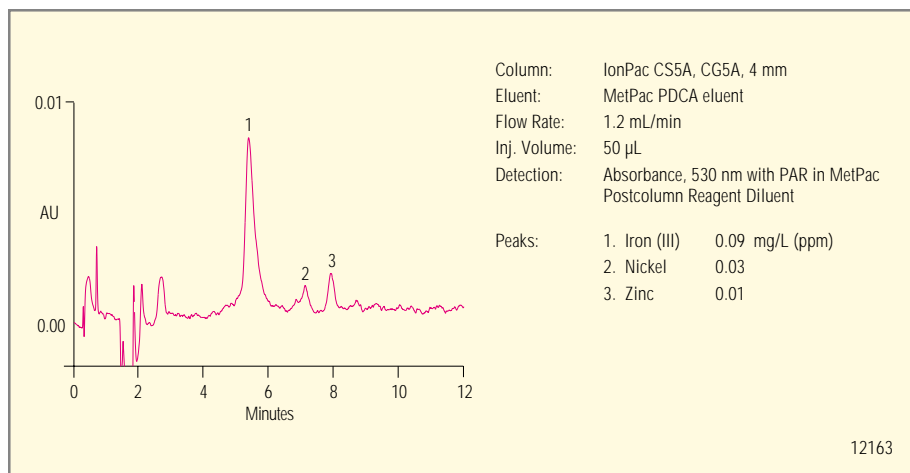

Figure 3. Determination of transition metals in HPLC-grade phosphoric acid (1:20 dilution)

Economical Microbore Operation

The IonPac CS5A column is available in the 2-mm format for microbore separations to offer the advantage of reduced operating costs (see Figures 6 and 7).

- Ideal for limited sample volumes due to higher mass sensitivity compared to 4-mm separations
- Three- to fourfold reduction in eluent and postcolumn reagent consumption
- 4-mm applications can be directly transferred to the 2-mm format
- Optimized 2-mm PC10 Postcolumn Delivery System

Chelation Chromatography Sample Pretreatment

Chelation concentration chromatography can be used to eliminate alkali and alkaline earth interferences prior to the determination of transition or lanthanide metals by IC, AA, ICP, or ICP-MS. The IonPac CS5A is fully compatible with chelation concentration chromatography.

Chelation concentration ion chromatography combines the selectivity of chelation concentration sample pretreatment with the separation and sensitivity of ion chromatography, and is ideal for determining transition metals and lanthanides in complex matrices, such as seawater, brines, soils, acid digests, chemicals, and biological fluids.

Sample pretreatment and concentration can be automated using the MetPac CC-1, a special chelating concentration column. The MetPac CC-1 column selectively concentrates the analytes of interest and eliminates interfering alkali and alkaline-earth metals. This technique is ideal for the concentration of transition metals from high ionic strength matrices.

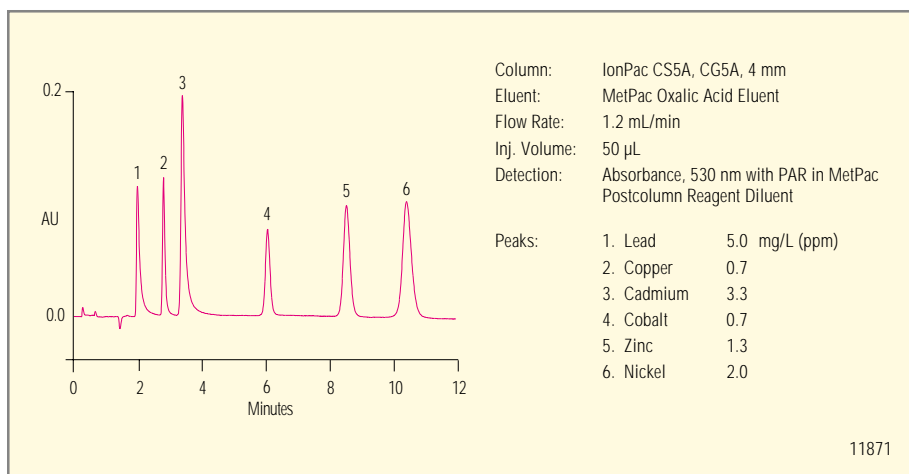

Figure 4. Separation of transition metals by a mixed mode mechanism using oxalate as a complexing agent.

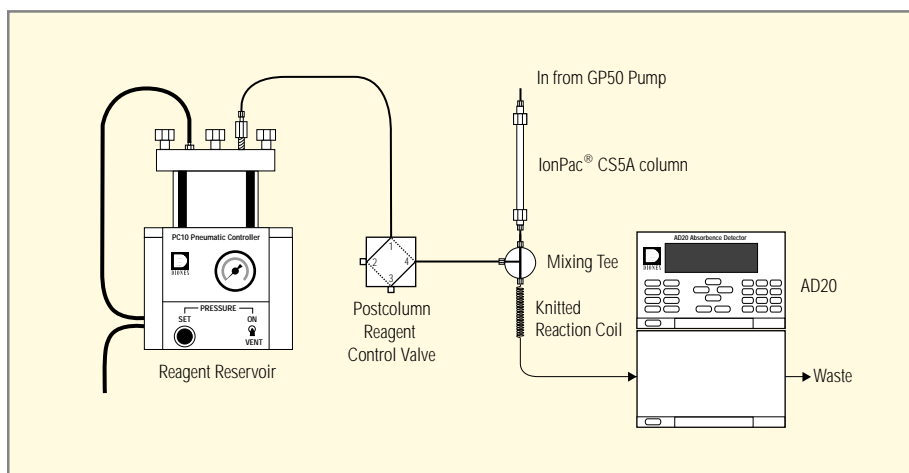

Figure 5. Schematic of the PC10 Postcolumn Delivery System.

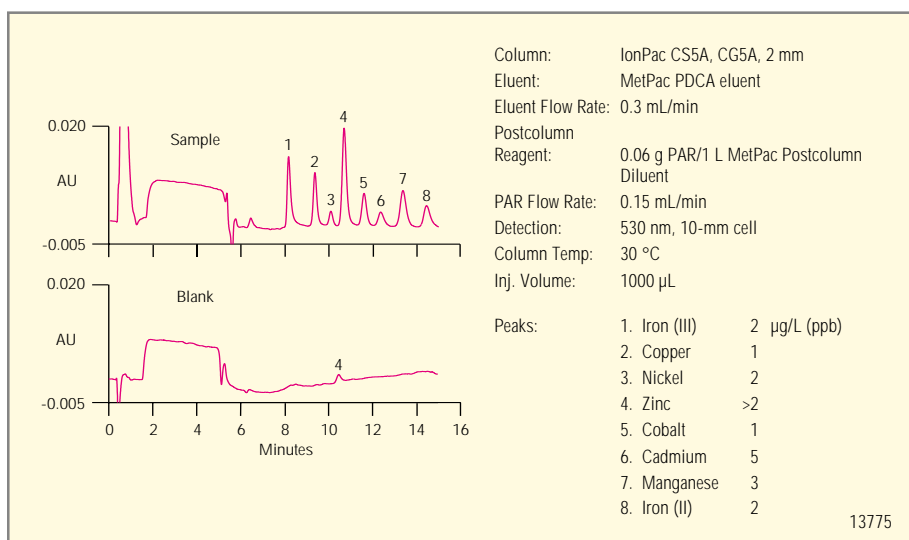

Figure 6. Large sample loop injection of µg/L levels of transition metals in a 2-mm system with PC10 pneumatic postcolumn delivery.

The concentrated transition metals are then eluted onto the TMC-1, a high-capacity cation concentrator column. The TMC-1 column concentrates transition metals eluted from the MetPac CC-1 concentrator column, which are then eluted onto the IonPac CS5A analytical column.

For complete information on chelation ion chromatography, please refer to the following Dionex documents:

- Technical Note 27: Determination of Lanthanide Metals in Digested Rock Samples by Chelation Ion Chromatography
- Technical Note 28: Ion Chromatography/Inductively Coupled Argon Plasma (IC/ICAP): A New Technique for Trace Metal Determinations
- Technical Note 29: Automated Sample Preconcentration of Metals in Drinking Water for Inductively Coupled Argon Plasma (ICAP) Spectroscopy

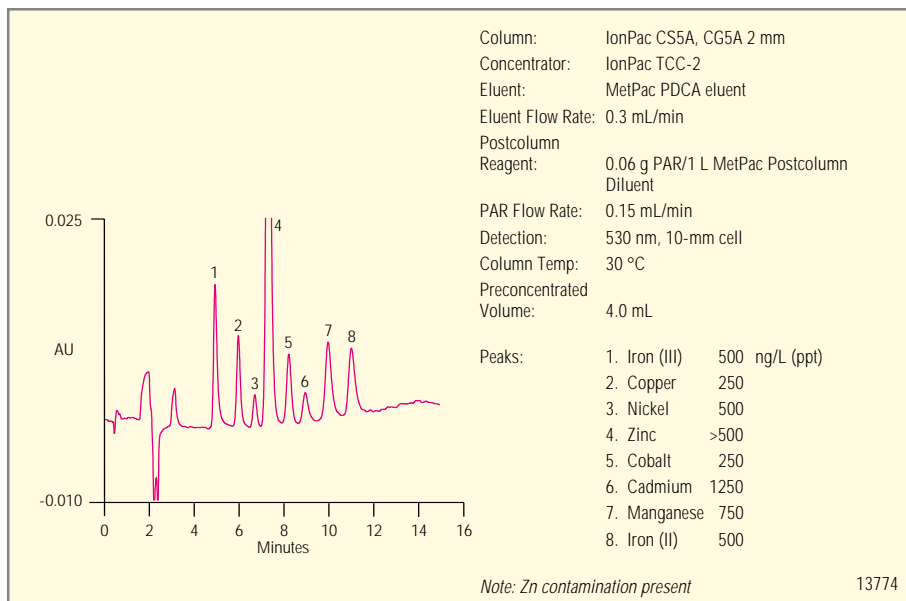

Figure 7. Preconcentration of ng/L levels of transition metals using 2-mm transition metal system with reagent pump postcolumn delivery.

SPECIFICATIONS*Dimensions:*

Analytical Column:
4 x 250 mm and 2 x 250 mm
Guard Column:
4 x 50 mm and 2 x 50 mm

Maximum Operating Pressure:

17.3 MPa (2500 psi)

Chemical Compatibility:

Typical HPLC solvents to 50%

Column Construction:

PEEK with internal style 10-32 threaded ferrule-style end fittings.
All components are nonmetallic.

Resin Composition:

Bead diameter: 9 µm
Crosslinking (% DVB): 55%

MicroBead™ Latex:

Bilayer of anion-exchange and cation-exchange latex

Anion Exchange:

Latex Diameter: 76 nm
Crosslinking: 2%
Capacity:
40 µeq/column (4 x 250 mm)
10 µeq/column (2 x 250 mm)

Ion-Exchange Group:

Quaternary ammonium

Cation-Exchange:

Latex Diameter: 140 nm
Crosslinking: 10%
Capacity:
20 µeq/column (4 x 250 mm)
5 µeq/column (2 x 250 mm)
Ion-Exchange Group:
Sulfonic acid

ORDERING INFORMATION

In the U.S., call 1-800-346-6390, order online at <http://dstore.dionex.com>, or contact the Dionex regional office nearest you. Outside the U.S., order through your local Dionex office or distributor. Refer to the following part numbers.

Description	Part Number
Columns and Reagents	
IonPac CS5A Analytical Column (4 x 250 mm)	046100
IonPac CG5A Guard Column (4 x 50 mm)	046104
IonPac CS5A Analytical Column (2 x 250 mm)	052576
IonPac CG5A Guard Column (2 x 50 mm)	052836
MetPac PDCA Eluent Concentrate, 5X concentrate (1000 mL)	046088
MetPac Oxalic Acid Eluent Concentrate, 10X concentrate (500 mL)	046091
MetPac PAR Postcolumn Diluent (1000 mL)	046094
Ready-to-use diluent for 4-(2-pyridylazo) resorcinol (PAR). Requires PAR chemical (P/N 039672).	
Transition Metal Chemicals	
4-(2-Pyridylazo) resorcinol (PAR), 5 g	039672
Pyridine-2,6-dicarboxylic acid (PDCA), 20 g	039671
Chelation Concentrator Columns	
MetPac CC-1 Chelating Column (4 x 50 mm), pkg. of 2	042156
TMC-1 Concentrator (3 x 25 mm)	049000
Postcolumn Reaction Components	
PC10 Postcolumn Pneumatic Delivery Package (4 mm)	050601
Required for delivery of postcolumn reagents in standard bore 4-mm i.d. systems. Includes: PC10 Pneumatic Controller; Pressurizable Reservoir Chamber; 1-L Reagent Container; 375-µL Knitted Reaction Coil; Mixing Tee (4 mm); and required tubing and fittings.	
Knitted Reaction Coil, 375 µL, unpotted	043700
For use with 4-mm columns.	
PC10 Postcolumn Pneumatic Delivery Package (2 mm)	053591
Required for delivery of postcolumn reagents in 2-mm i.d. systems. Includes: PC10 Reagent Organizer; PC10 Pneumatic Controller; Pressurizable Reservoir Chamber; 1-L Reagent Container; 125-µL Knitted Reaction Coil; Mixing Tee (2 mm); and required tubing and fittings.	
Knitted Reaction Coil, 125 µL, unpotted	053460
For use with 2-mm columns.	
PC10 Automation Kit	050603
Automated on/off valve permits TTL control of postcolumn reagent flow.	



IonPac is a registered trademark and MetPac and MicroBead are trademarks of Dionex Corporation.

Printed on recycled and recyclable paper.

Dionex Corporation
1228 Titan Way
P.O. Box 3603
Sunnyvale, CA
94088-3603
(408) 737-0700

Dionex Corporation
Salt Lake City Technical Center
1515 West 2200 South, Suite A
Salt Lake City, UT
84119-1484
(801) 972-9292

Dionex U.S. Regional Offices
Sunnyvale, CA (408) 737-8522
Westmont, IL (630) 789-3660
Houston, TX (281) 847-5652
Atlanta, GA (770) 432-8100
Marlton, NJ (856) 596-0600

Dionex International Subsidiaries

Austria (01) 616 51 25 *Belgium* (015) 203800 *Canada* (905) 844-9650 *China* (852) 2428-3282 *Denmark* (45) 36-36-90-90 *France* 01 39 30 01 10
Germany 06126-991-0 *Italy* (06) 66 51 50 52 *Japan* (06) 6885-1213 *The Netherlands* (0161) 43 43 03 *Switzerland* (062) 205 99 66
United Kingdom (01276) 691722

* Designed, developed, and manufactured under an NSAI registered ISO 9001 Quality System.



LPN 0745-03 2M 7/01
©2001 Dionex Corporation